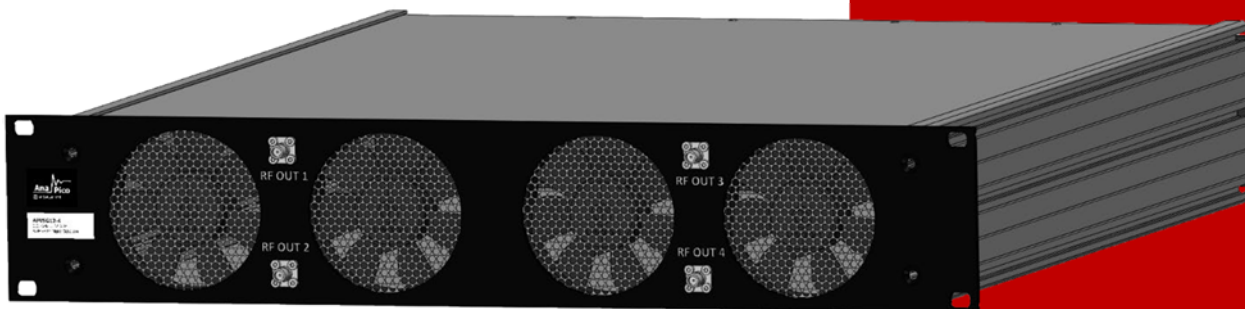


# DATASHEET RFVSG Specification V1.21

Single- and Multi-Channel Ultra-Agile Vector Signal Generators

Models up to 4, 6, 12, 20, and 40 GHz



**Document size:**

1 title page  
23 content pages

## DEFINITIONS

The specifications in the following pages describe the warranted performance of the instrument for  $23 \pm 5$  °C after a 30-minute warm-up period

**Typical:** Expected mean values, not warranted performance

**Min and max:** Parameter range that is guaranteed by product design, and/or production tested. Warranted performance specifications include guard-bands to account for the expected statistical performance distribution, measurement uncertainties, and changes in performance due to environmental conditions.

## INTRODUCTION

### Ultra-Agile Vector Signal Generator

The RFVSG is an ultra-fast-switching vector-modulated signal generator series covering a continuous frequency ranges from 10 MHz to 4, 6, 12, 20, or 40 GHz, respectively, with 0.001 Hz resolution, and 400 MHz RF modulation bandwidth.

The RFVSG is the corresponding multi-channel product series.

A high performance internal I/Q modulator enables customized waveforms as modulation signals and supports variety of modulation schemes including avionics modulation. The internal dual channel arbitrary waveform generator fitted ensures carrier suppression of >80 dB and image suppression of >75 dB.

The standard RFVSG enables ultra-fast CW frequency sweeping, chirping, intra-pulse modulation, pulse shaping with very low phase noise.

Among others, the following use cases are supported:

- Upload multiple formats of IQ Data into RFVSG Memory. An RFVSG GUI supports data formats from various vendors. The internal RAM can store up to 512 MS (32 bits per Sample) of IQ data. The RFVSG internal AWG can play selected sections of the RAM upon a user trigger.
- Use RFVSG to synthesize and play predefined digital modulation formats (option IVM)
- Use FCP interface (option FCP) to live stream and play digital IQ data up to 125/250 MS/s.
- Use the analog IQ inputs (option EIQ) with up to 250 MHz IQ bandwidth
- Use FCP (option FCP) to instantaneously switch between pre-loaded IQ data segments
- Use FCP to control the RFVSG for ultra-fast frequency hopping (options UFS, FCP)

All RFVSGs operate with an ultra-stable temperature compensated frequency reference (OCXO) that can be phase-locked to an external reference.

The compact unit allows for full front panel control via touch panel display, and PC GUI Software supported operation via ETHERNET, USB, FCP (fast control port) and GPIB communication ports.

# FACTS & FIGURES & SPECIFICATIONS

## Signal Specifications

PARAMETER	MIN	TYPICAL	MAX	NOTE
<b>Frequency Range</b>	10 MHz		4 GHz 6 GHz 12 GHz 20 GHz 40 GHz	RFVSG04 RFVSG06 RFVSG12 RFVSG20 RFVSG40
<b>Frequency Resolution</b>		0.001 Hz		
<b>Phase Resolution</b>		0.01 deg		
<b>Frequency &amp; Amplitude Switching / Settling Time</b>		1.5 ms 500 $\mu$ s 200 ns 800 ns		valid signal after SCPI received List sweep within 400 MHz BW, Option UFS within entire frequency range, Option UFS
<b>Output Power Level</b>				
0.01 to 1 GHz	-65 dBm		+19 dBm	APVS4
1 to 2 GHz			+16 dBm	
>2 GHz			+13 dBm	
0.01 to 6 GHz	-60 dBm		+15 dBm	RFVSG6
0.01 to 12 GHz	-60 dBm		+15 dBm	RFVSG12
0.01 to 20 GHz	-60 dBm		+15 dBm	RFVSG20
0.01 to 20 GHz 20 to 40 GHz	-60 dBm		+15 dBm +12 dBm	RFVSG40
<b>Power Resolution</b>		0.01 dB		
<b>Power Level Uncertainty</b>				
<4 GHz		0.25 dB	0.7 dB	Digital ALC on, >-20dBm
4 to 6 GHz		0.3 dB	1.0 dB	
6 to 20 GHz		0.3 dB	1.3 dB	
20 to 40 GHz			1.5 dB	
<4 GHz		0.3 dB	0.8 dB	Pmin to -20 dBm
4 to 6 GHz		0.35 dB	1.2 dB	
6 to 20 GHz		0.4 dB	1.3 dB	
20 to 40 GHz			1.5 dB	
<b>Reverse Power Protection</b>				
DC Voltage			$\pm$ 10 V	
RF Power			26 dBm	
<b>Output Impedance</b>		50 $\Omega$		
VSWR		1.8		See Figure 13
<b>SSB Phase Noise at 1 GHz and 10 dBm</b>				See Figures 1, 2
at 10 Hz from carrier		-87 dBc/Hz -100 dBc/Hz		Option LN
at 1 kHz from carrier		-130 dBc/Hz		
at 20 kHz from carrier		-145 dBc/Hz		
at 100 kHz from carrier		-150 dBc/Hz		
<b>SSB Phase Noise at 4 GHz and 10 dBm</b>				See Figures 1, 2
at 10 Hz from carrier		-74 dBc/Hz -90 dBc/Hz		Option LN
at 1 kHz from carrier		-121 dBc/Hz		
at 20 kHz from carrier		-133 dBc/Hz		
at 100 kHz from carrier		-138 dBc/Hz		
<b>SSB Phase Noise at 10 GHz and 10 dBm</b>				See Figures 1, 2
at 10 Hz from carrier		-67 dBc/Hz -80 dBc/Hz		Option LN
at 1 kHz from carrier		-113 dBc/Hz		
at 20 kHz from carrier		-124 dBc/Hz		
at 100 kHz from carrier		-130 dBc/Hz		
<b>SSB Phase Noise at 40 GHz and 10 dBm</b>				See Figures 1, 2

at 10 Hz from carrier		-55 dBc/Hz -68 dBc/Hz		Option LN
at 1 kHz from carrier		-101 dBc/Hz		
at 20 kHz from carrier		-112 dBc/Hz		
at 100 kHz from carrier		-118 dBc/Hz		
<b>Harmonics (at +5 dBm output)</b>		-50 dBc -60 dBc -60 dBc tbd tbd	-45 dBc -55 dBc -55 dBc tbd tbd	See Figure 4 0.01 to 4 GHz 4 to 6 GHz, RFVSG6/12 6 to 12 GHz, RFVSG12 4 to 20 GHz, RFVSG20/40 20 to 40 GHz, RFVSG40
<b>Sub-Harmonics (at 0 dBm output)</b>		-75 dBc -65 dBc -60 dBc		< 6 GHz 6 to 20 GHz > 20 GHz
<b>Non-Harmonic Spurious (at 0 dBm output, &gt; 10 kHz offset)</b>		-90 dBc -92 dBc -80 dBc -75 dBc -70 dBc -65 dBc	-85 dBc -88 dBc -60 dBc -60 dBc -60 dBc -55 dBc	< 1.2 GHz 1.2 to 2.5 GHz 2.5 to 4 GHz 4 to 12 GHz 12 to 20 GHz > 20 GHz



## Digital Modulation

PARAMETER	MIN	TYPICAL	MAX	NOTE
<b>I/Q Modulator</b>				
RF modulation bandwidth		400 MHz		
Carrier leakage			-70 dBc	
Image sideband rejection			-65 dBc	
<b>RF Path Filters</b>				
Band 0	0.01 GHz		2.5 GHz	
Band 1	2.5 GHz		3.5 GHz	
Band 2	3.5 GHz		4.5 GHz	
Band 3	4.5 GHz		6 GHz	
Band 4	6 GHz		8 GHz	
Band 5	8 GHz		10 GHz	
Band 6	10 GHz		12 GHz	
<b>Internal I/Q Baseband Generator</b>				
Resolution		I and Q 16 bits		For I and Q each
Waveform clock (sample rate)	10 Hz		500 MHz	
Clock frequency resolution		1 Hz		
<b>Waveform Segments</b>				
Fastest access	1		128	min latency
General access	1		65536	850 ns latency
Waveform sequencer playlist	1		2048	
Trigger modes	Same segment, next segment, addressed segment			
Arbitrary Waveform Memory for Playback		512 MSa		
<b>Markers</b>				
Markers are defined in a segment during the waveform generation process. A marker can also be routed to the RF blanking and/or external output.				
Number of Markers		3		
Operation modes	RF blanking, Trigger out			

## Internal Modulation Supported, Option IVM

PARAMETER	MIN	TYPICAL	MAX	NOTE
<b>Modulation schemes</b>	ASK, PSK, N-FSK, QAM 4 to 1024			
ASK depth	0 %		100 %	0.1 % resolution
FSK deviation	10 Hz		200 MHz	0.1 Hz resolution
QAM		Tbd		
Symbol rate	100 S/s		10 MS/s	
<b>Multicarrier Generation</b>				
Number of carriers	1		1024	
Frequency offset	-200 MHz		200 MHz	
Power offset	-60 dB		0 dB	0.1 dB resolution
Tone initial phase offset	0 deg		360 deg	0.1 deg resolution

## Avionics Modulation, Option AVIO

<b>AVIO Modulation DME</b>				
Operating modes	interrogation & reply			
DME channel	X, Y			
Frequency range	960 MHz		1215 MHz	
Pulse on/off ratio		80 dB	70 dB	
Pulse rise/fall times	100 ns		50 µs	100 ns resolution
Pulse width	100 ns		50 µs	100 ns resolution
Pulse spacing	100 ns		300 µs	100 ns resolution
Pulse rate	10 Hz		10 kHz	1 Hz resolution
Pulse shaping	cos, cos <sup>2</sup> linear, gauss			individually settable for rising & falling edge
ID code				
ID rate				
<b>AVIO Modulation VOR</b>				
Bearing accuracy	108 to 118 MHz	±2% / ±0.5 deg		
Subcarrier frequency accuracy	9960 ± 2 Hz			
AM accuracy		30 ± 1%		
AM distortion (THD)			2%	
FM accuracy		480 ± 1 Hz		
<b>AVIO Modulation ILS</b>				
AM accuracy	108 MHz	40 ± 1%	112 MHz	
AM distortion				
DDM resolution		0.0002 0.0004		Localizer Glide Slope
DDM accuracy		0.0004 0.0008		Localizer Glide Slope
<b>Marker Beacon</b>				
AM tone accuracy (95% AM)		5% of setting		
AM tone distortion (95% AM)		5%		



## Analog Modulation (Option MOD)

PARAMETER	MIN	TYPICAL	MAX	NOTE
<b>Pulse Modulation</b>				
Modulation source		Internal / External		
Pulse rise/fall time		5 ns		10% / 90% of amplitude

On/off ratio		80 dB 75 dB	70 dB 60 dB	< 5.5 GHz elsewhere
Pulse overshoot			1 dB	
Pulse Repetition Frequency (PRF)	0.1 Hz		62.5 MHz	= 1/T
Minimum pulse settling range	8 ns		1 s	
Pulse Pattern Modulation & Staggered PRF				Using internal pattern generator
Programmable pattern length	2		65536	
Duty cycle	0.05%		99.95%	
Pulse width resolution		2 ns		
Pulse period (T) accuracy		same as timebase		
Pulse width accuracy		same as timebase		
Pulse jitter			<1 ps	
Polarity		selectable		
<b>Amplitude Modulation</b>				
Modulation source		Internal / External		External requires option AIQ
Modulation depth	0%		100%	Output is clipped at max power level
Deviation accuracy		0.1%	1%	1 kHz rate, 30% depth
Deviation resolution		0.1%		
Distortion (THD)			1%	1 kHz rate, 30% depth
Modulation frequency range	0.1 Hz		100 MHz	
Modulation waveforms		Sine, Square		
<b>Frequency Modulation</b>				
Modulation source		Internal / External		External requires option AIQ
Maximum frequency deviation (peak)		200 MHz		
Deviation accuracy		0.5%	1%	
Distortion (THD)		< 1 %		1 kHz rate, 10 kHz deviation
Modulation frequency range	0.1 Hz		100 MHz	
Modulation waveforms		Sine		
<b>Phase Modulation</b>				
Modulation source		Internal / External		External requires option AIQ
Phase deviation (peak)	0		100 rad	
Deviation accuracy		0.5%	1%	
Modulation frequency range	0.1 Hz		100 MHz	
Modulation waveforms		Sine		
Distortion (THD)		< 1%		1 kHz rate & N x rad deviation



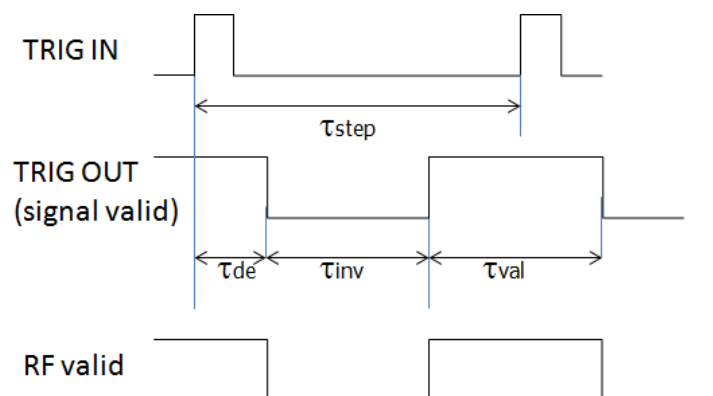
## Frequency Reference

PARAMETER	MIN	TYPICAL	MAX	NOTE
<b>Internal Reference Frequency</b>		100 MHz 10 MHz		Option LN
Initial calibrated accuracy			±10 ppb	At 23 ± 3 °C
Temperature stability			±100 ppb ±20 ppb	0 to 50 °C Option LN
Aging after 1st year			1 ppm 0.03 ppm	Option LN
Aging per day			5 ppb	after 30 days operation

			0.5 ppb	Option LN
Warm-up time		5 min		
Output of internal reference		10 or 100 MHz		
Output power		0 dBm		
Output impedance		50 $\Omega$		
<b>High Performance Phase Synchronization Clock</b>		3 GHz		
<b>Phase Lock to External Reference</b>	5	10 MHz integer MHz	250	Option VREF
<b>Reference Input Level</b>				
10 MHz or 1-250 MHz	-5 dBm	0 dBm	+10 dBm	
<b>Lock Range</b>				
10 MHz or 1-250 MHz			$\pm 1.5$ ppm	
<b>Reference Input Impedance</b>		50 $\Omega$		

## Sweeping Capability

PARAMETER	MIN	TYPICAL	MAX	NOTE
<b>Sweep Type</b>	List, linear, logarithmic, sawtooth, triangle, random			
<b>Frequency Sweep Range</b>	Full range			
<b>Sweep Parameters</b>	Frequency, power, phase			
Step time ( $t_{step}$ )	500 $\mu$ s 200 ns 800 ns		19998 s 19998 s	Option UFS, within +/- 200 MHz Option UFS, within full range
Settling time ( $t_{inv}$ )				To stabilize phase and amplitude, depends on frequency step
Trigger latency ( $t_{de}$ )		10 ns		Time from trigger to initiate signal transient
Time resolution		2 ns		
Timing accuracy per point		2 ns		



## Trigger Capability

PARAMETER	MIN	TYPICAL	MAX	NOTE
<b>Trigger Types</b>	Continuous, single (point), gated, gated direction			
<b>Trigger Source</b>	External (TRIG1/2), bus (LAN, USB)			
<b>Trigger Modes</b>	Continuous free run (AUTO), trigger and run, reset and run			
Trigger latency		10 ns		
Trigger uncertainty		2 ns		

External trigger delay	0		10 s	Settable
External delay resolution		2 ns		
<b>Trigger Polarity</b>	Rising, falling			

## Fast Control Port (Option FCP)

Parallel hardware interface for high-speed programming and external digital IQ data streaming.



PARAMETER	
<b>Interface</b>	Bidirectional LVDS with 100 Ohm termination at receiver
Common mode level	typ. 1.2V
Differential input threshold	typ. +/-100mV
Differential output voltage	typ. 300mV
Connector type	36-pin mini-D female
<b>Mode IQ data stream</b>	
Sampling rate (IQ samples)	Up to 125 MS/s (optional up to 250 MS/s)
Input/output format, interleaved clock	16 bits data + clock
Latency at 125MS/s	typ. 500ns
<b>Mode Multi segment waveform addressing</b>	
Input format	Up to 16 bits segment address + strobe
Latency at general access	typ. 850ns
<b>Mode Parameter hopping</b>	
Parameter	Frequency (up to 48bit), amplitude, phase
Input format	8 bits address + n* 8bits data + strobe

## External Analog I/Q Data Inputs, Option AIQ

PARAMETER	MIN	TYPICAL	MAX	NOTE
Analog bandwidth	100 MHz min			
Input impedance	50 Ω			
Voltage range	-0.5 V		0.5 V	
Full scale voltage		0.5Vrms		$\sqrt{I^2+Q^2}$
Input impedance		50 Ohms		
Connector Type	Rear I and Q inputs (BNC female)			

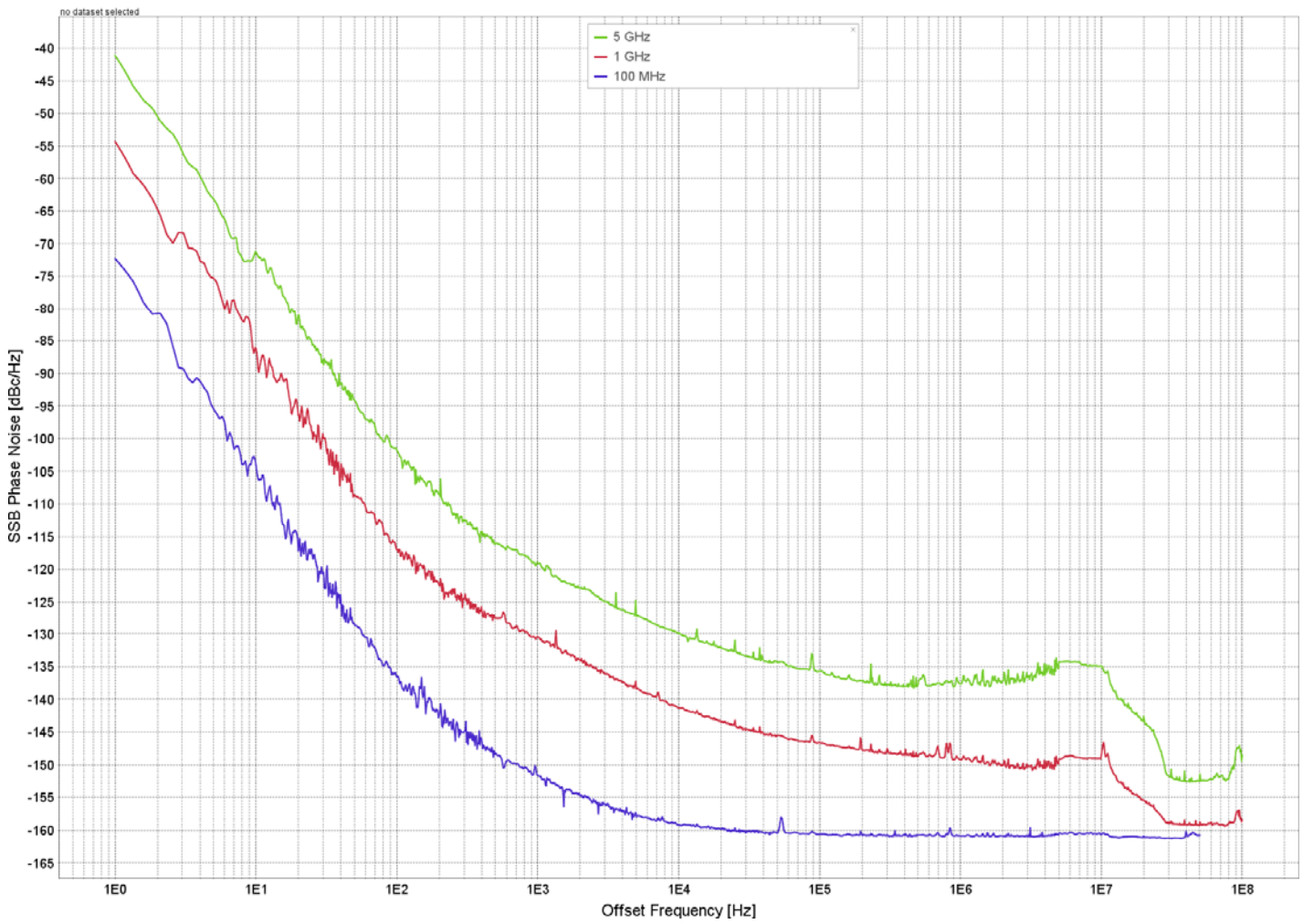
## Multi-Channel Performance

PARAMETER	MIN	TYPICAL	MAX	NOTE
Isolation between Channels		>100 dB		
Relative Phase Stability		tbd		




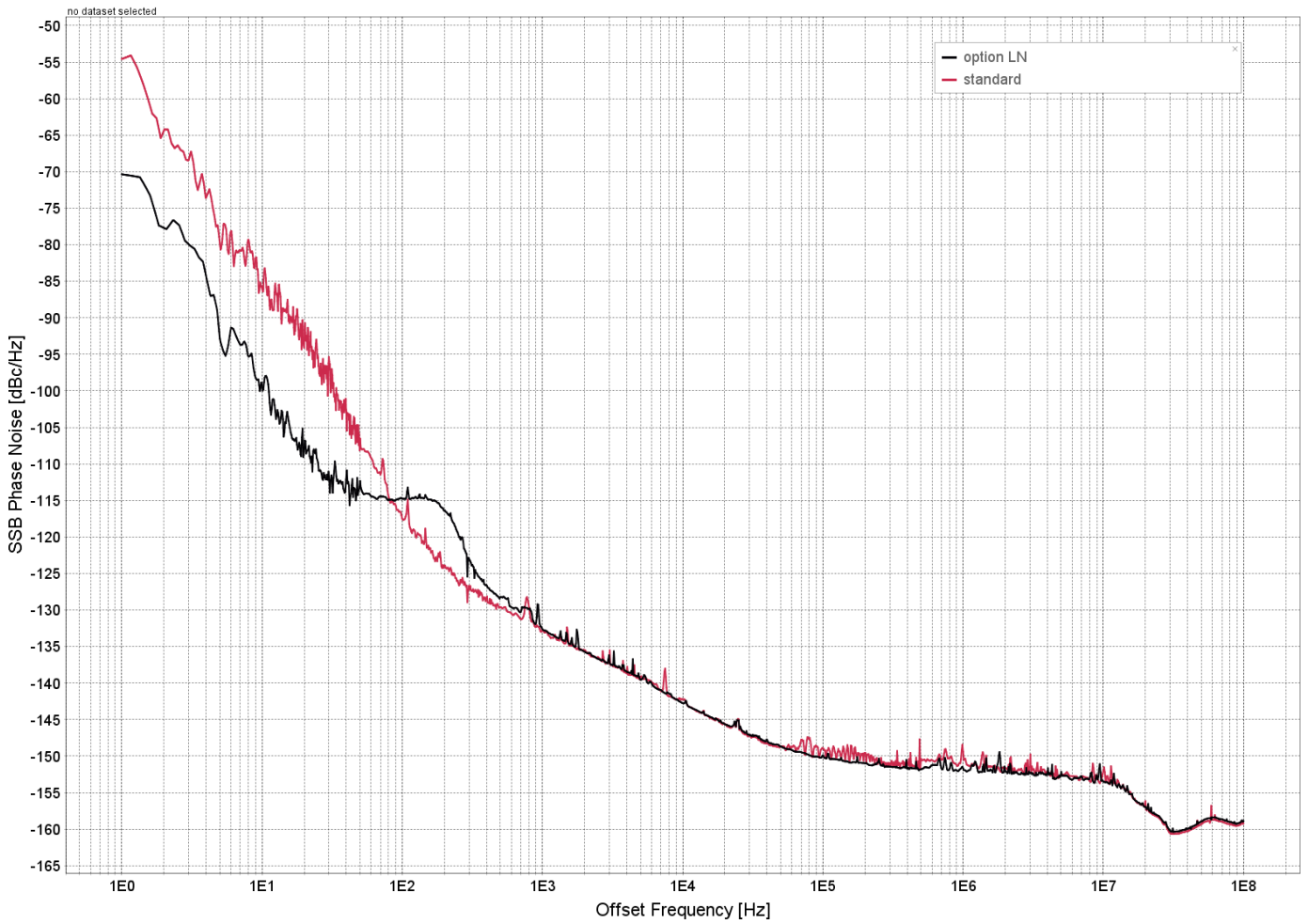
# TYPICAL PERFORMANCE CURVES

Figure 1: SSB Phase Noise Performance, CW without option LN, Pout = 10 dBm

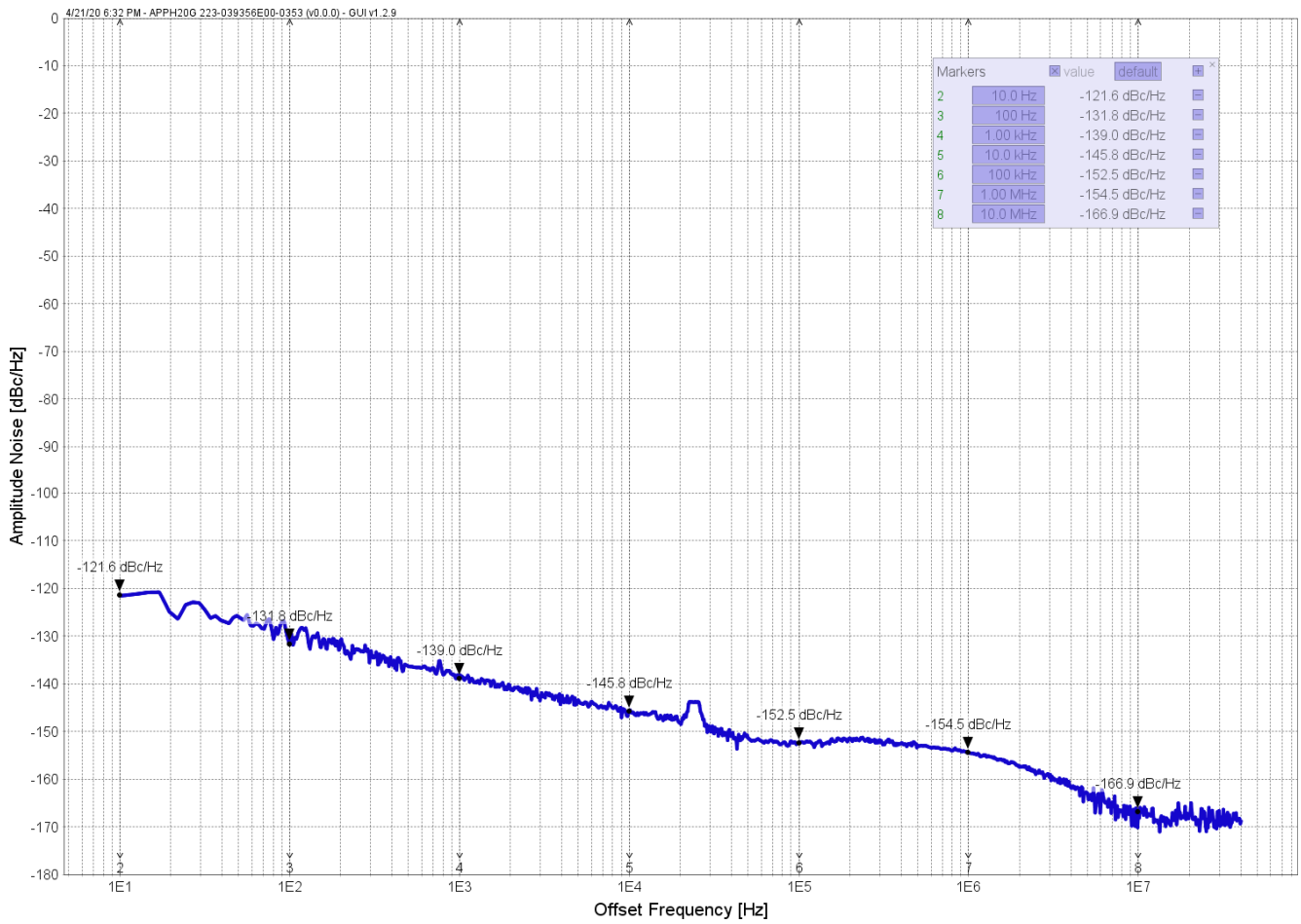


Offset → RF ↓	1 Hz	10 Hz	100 Hz	1 kHz	10 kHz	100 kHz	1 MHz	floor
100 MHz		-119	-135	-148	-155	-156	-158	-159
1 GHz		-100	-114	-129	-140	-150	-152	-160
4 GHz		-87	-102	-118	-129	-139	-140	-151

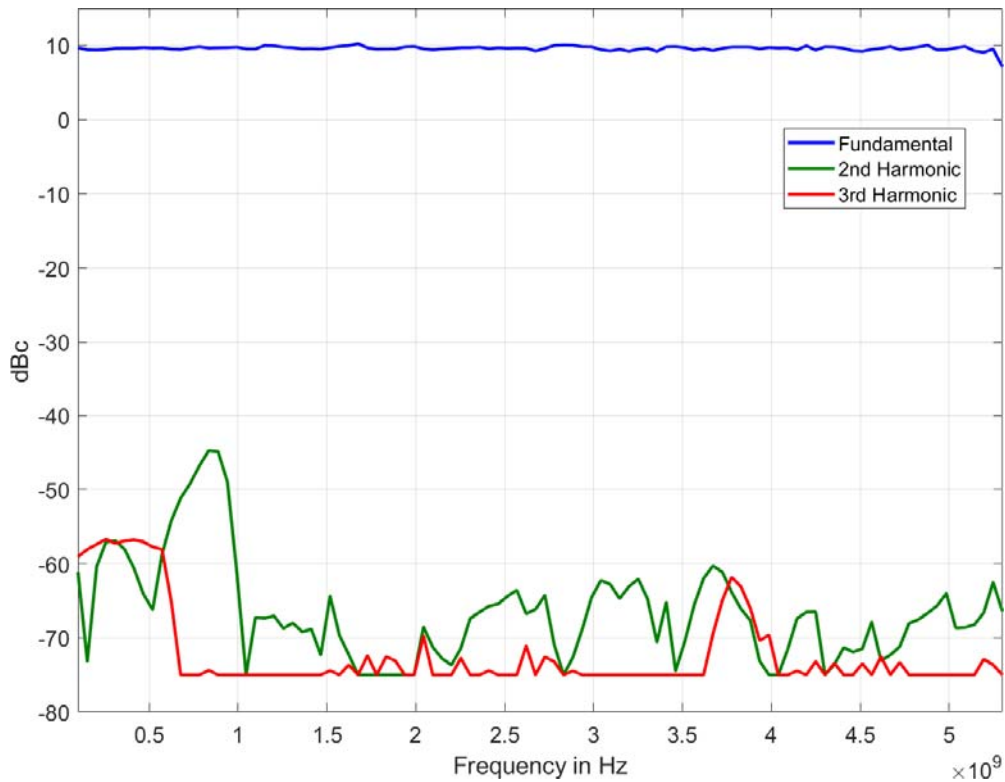
 **Figure 2: SSB Phase Noise Performance, CW with option LN, 1 GHz, Pout = 10 dBm**



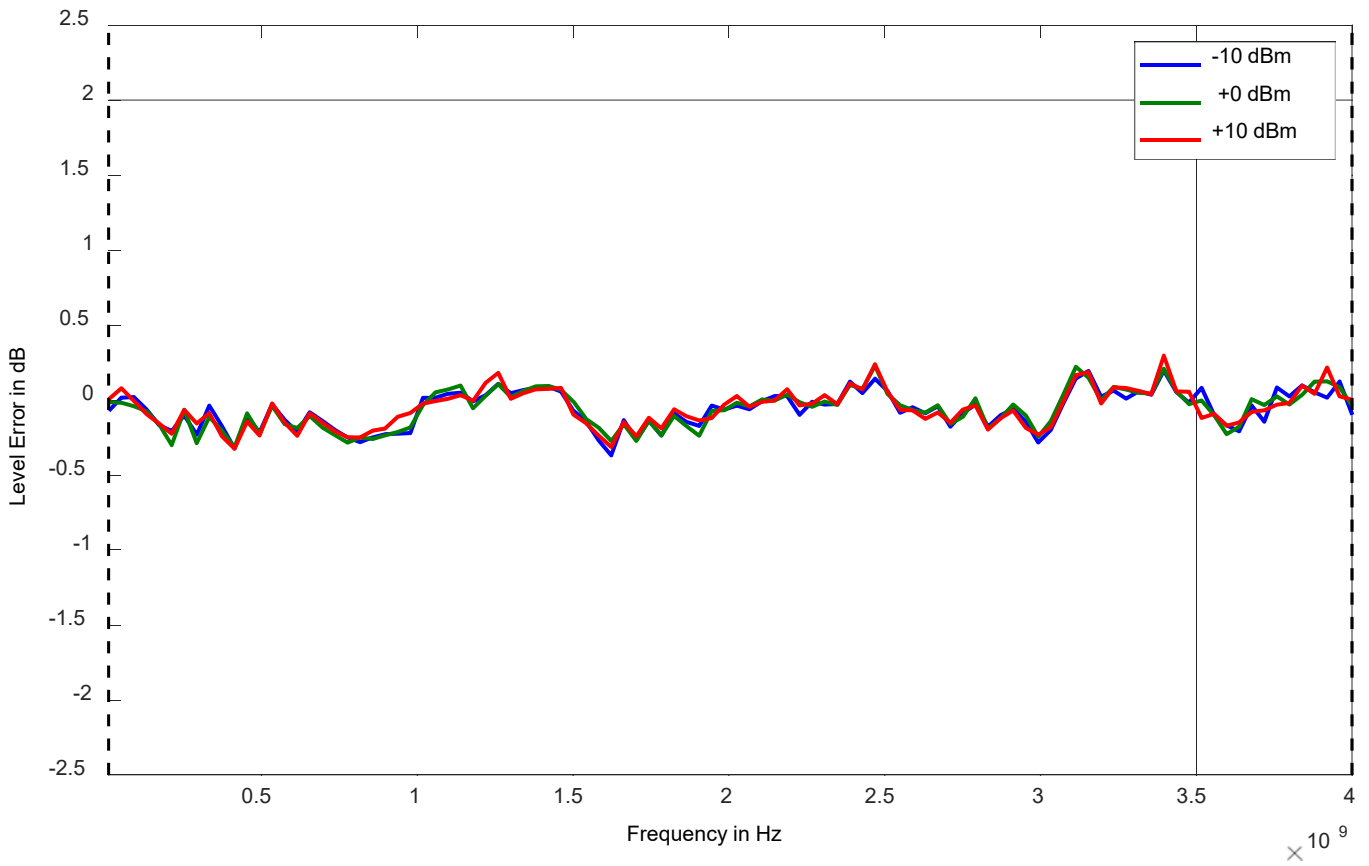
**Figure 3: Amplitude Noise, 2 GHz, Pout = 10 dBm**



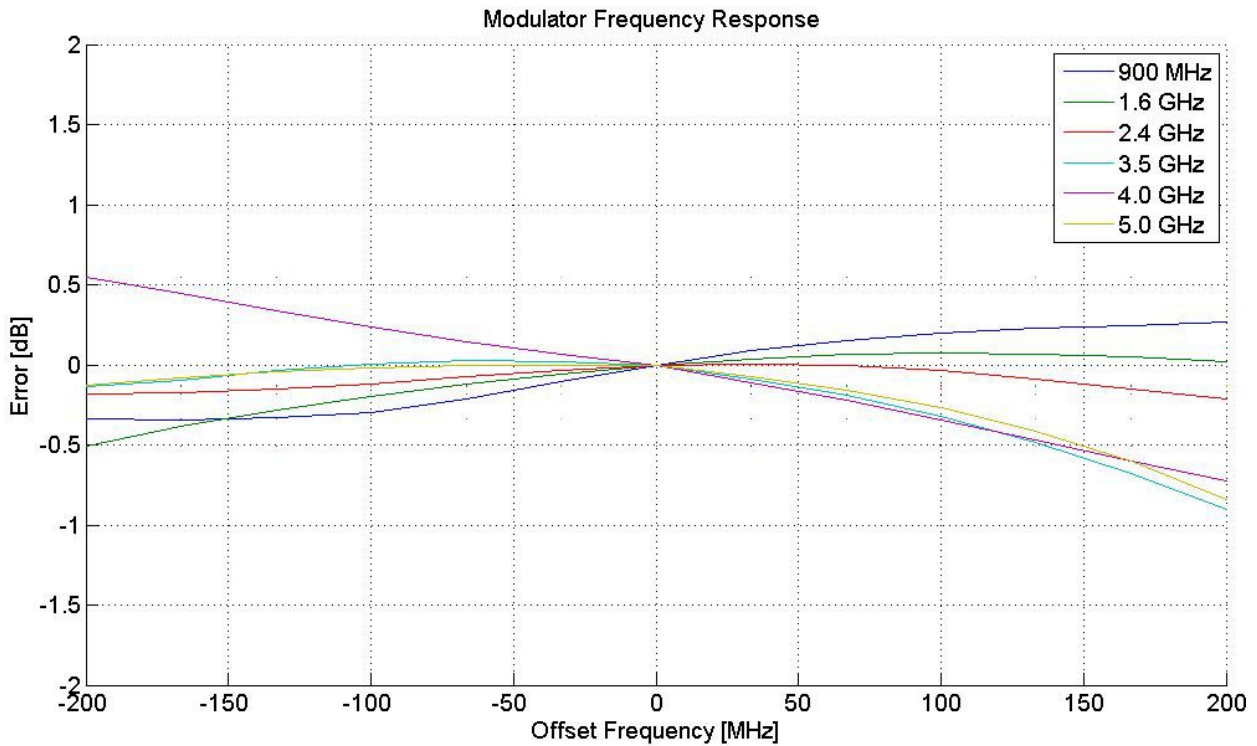
**Figure 3: Harmonic performance at 10 dBm**



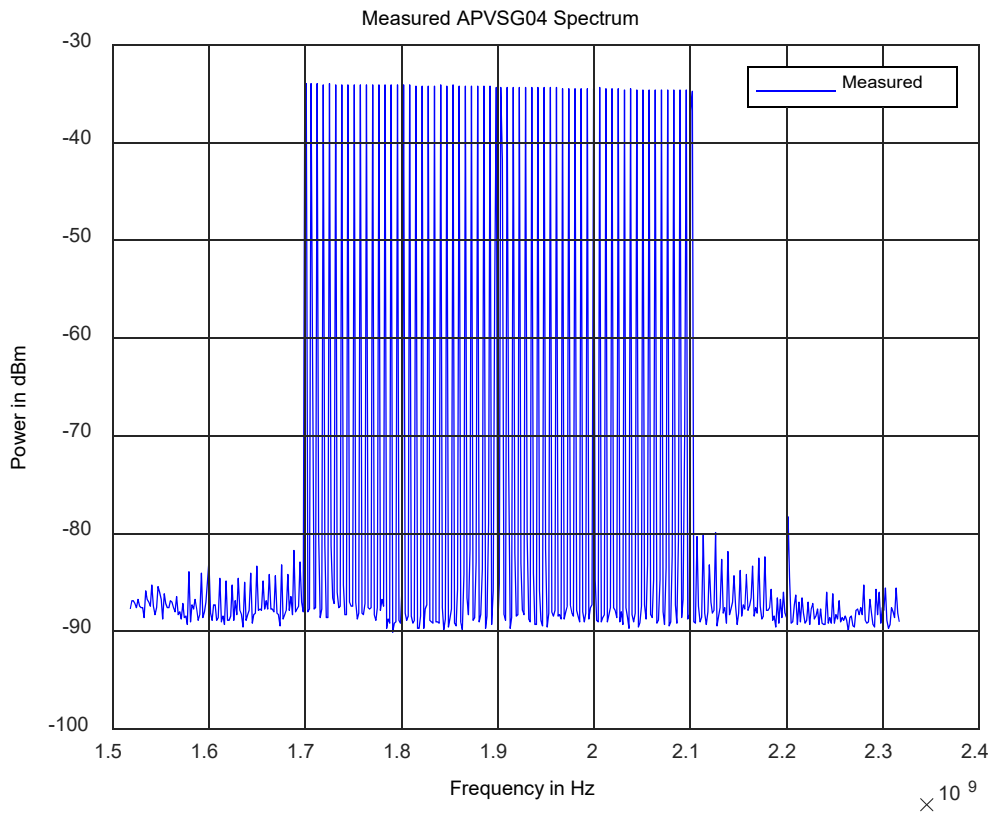
**Figure 4: Level accuracy**



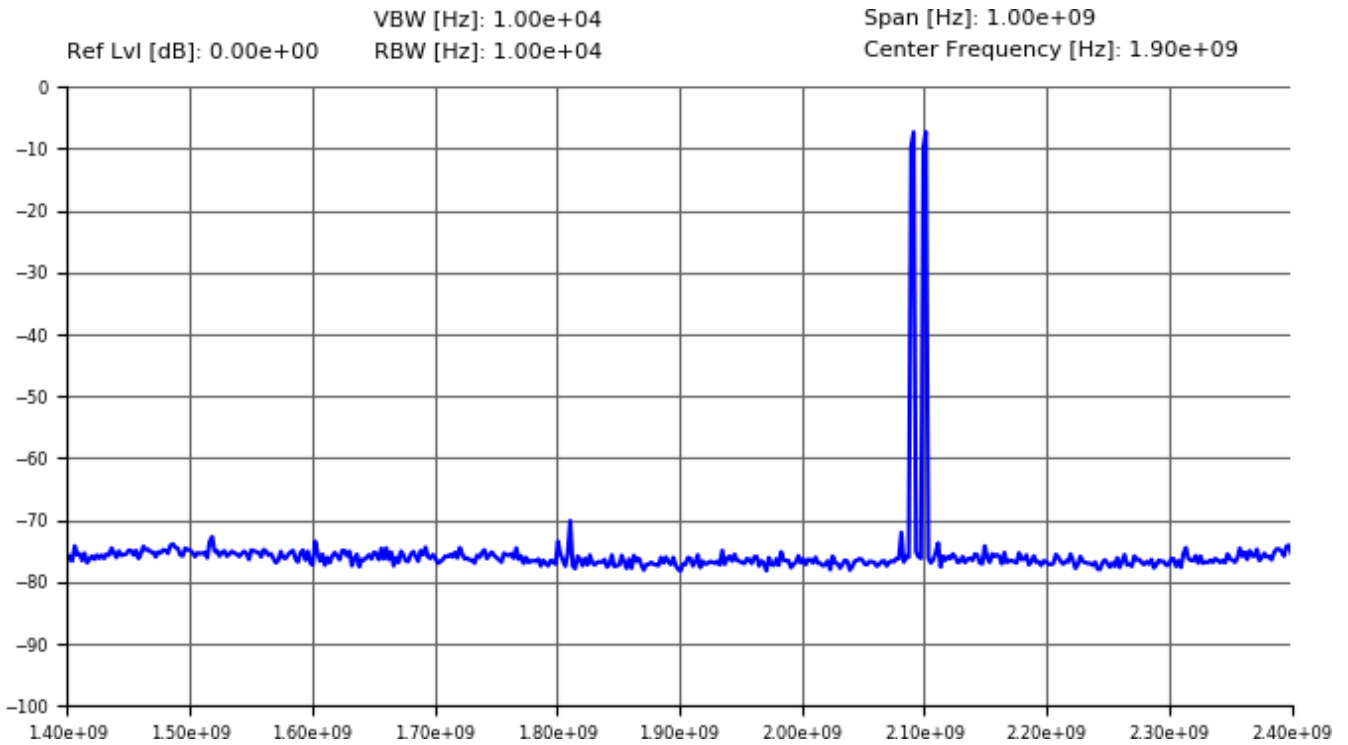
**Figure 5: IQ Relative Response (measured)**



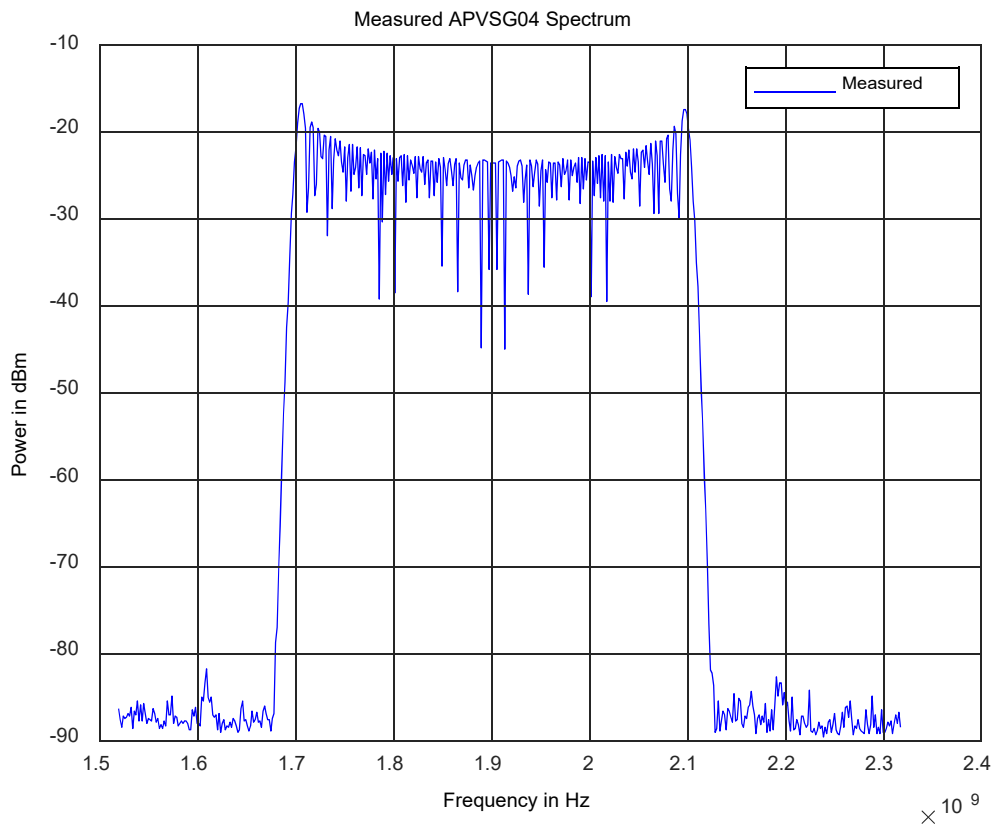
**Figure 5: 64-tone 400 MHz bandwidth signal**



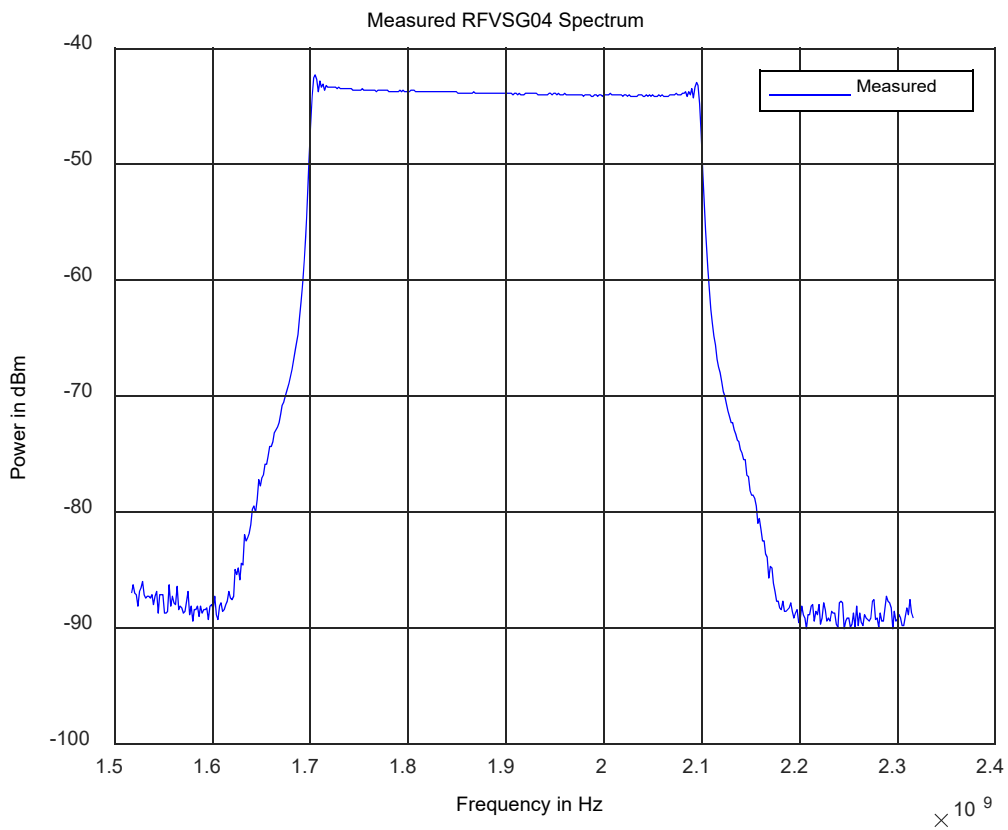
**Figure 6: Two-tone sideband rejection**



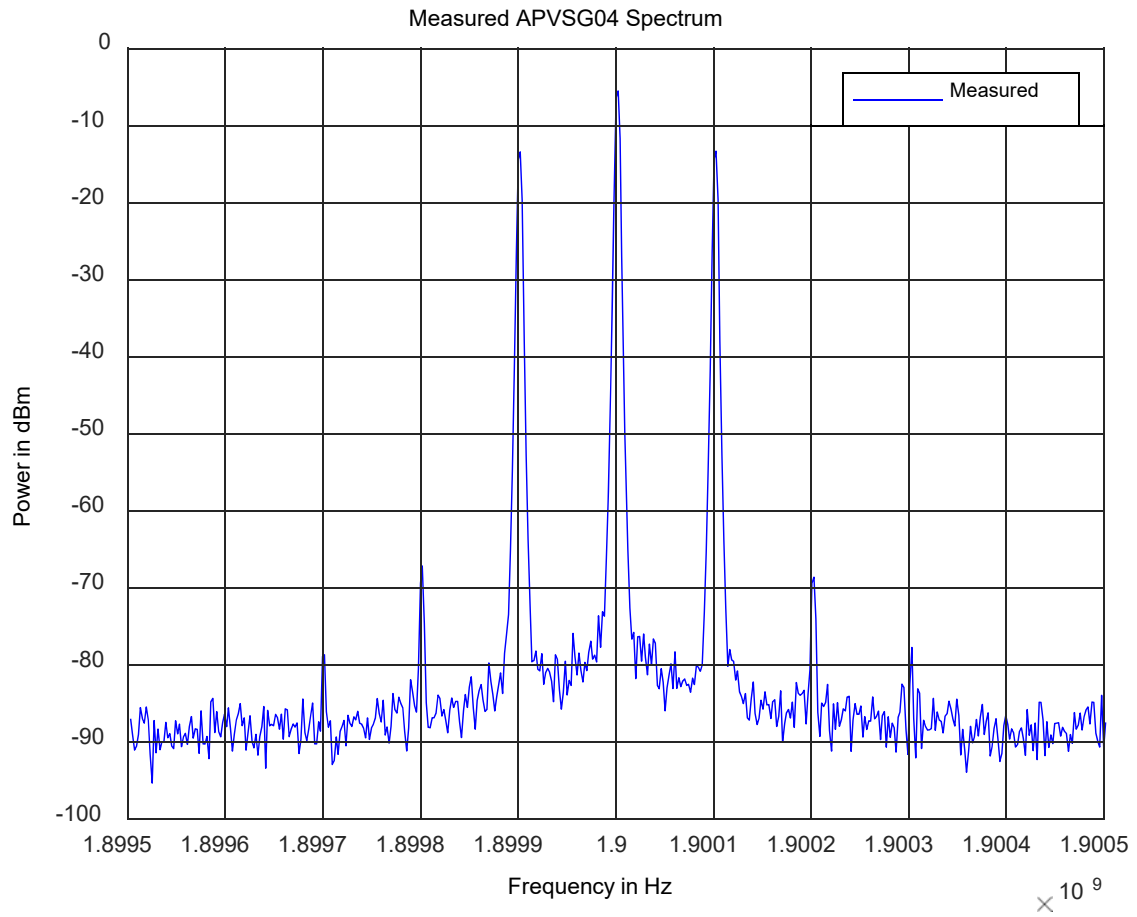
**Figure 7: Wideband FM (1MHz rate, 200 MHz deviation)**



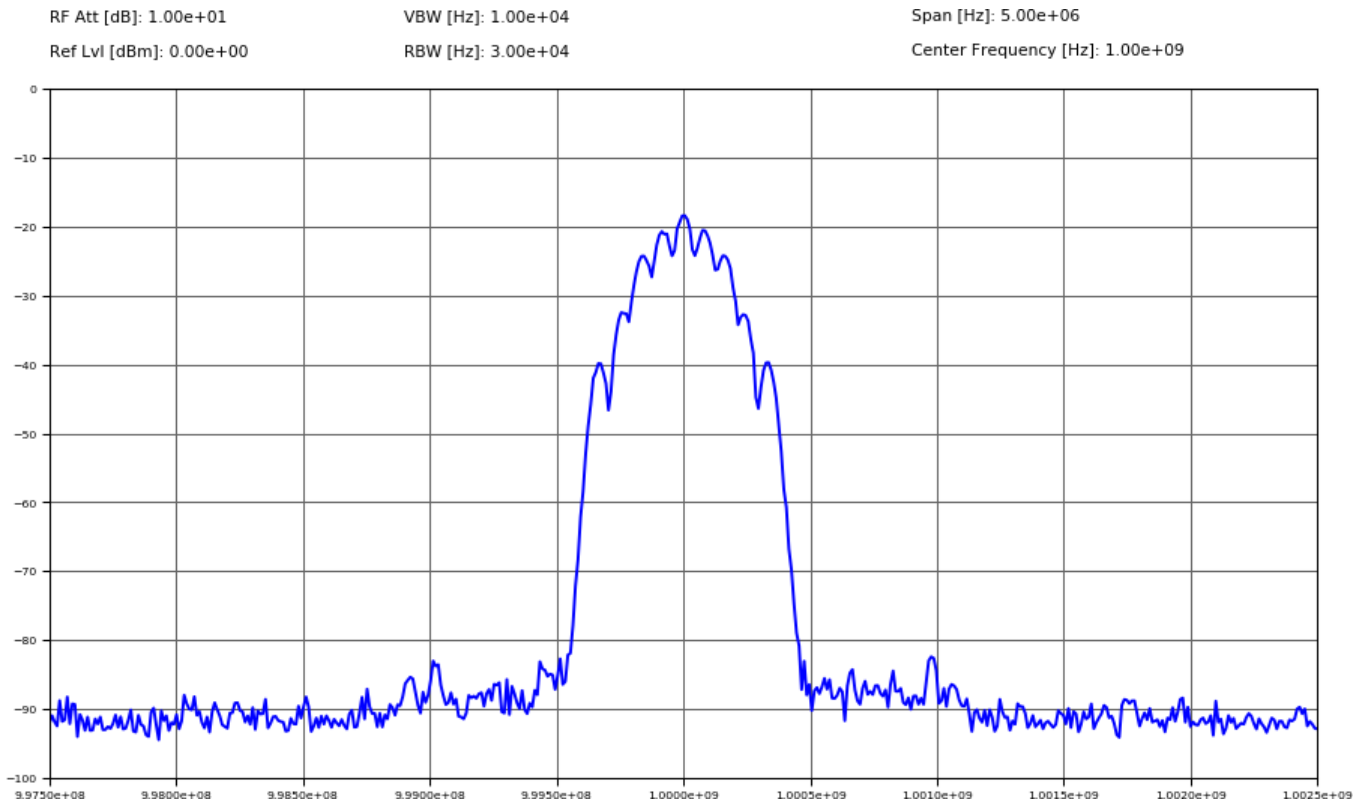
**Figure 8: Pulsed chirp (10 microseconds, 400 bandwidth)**



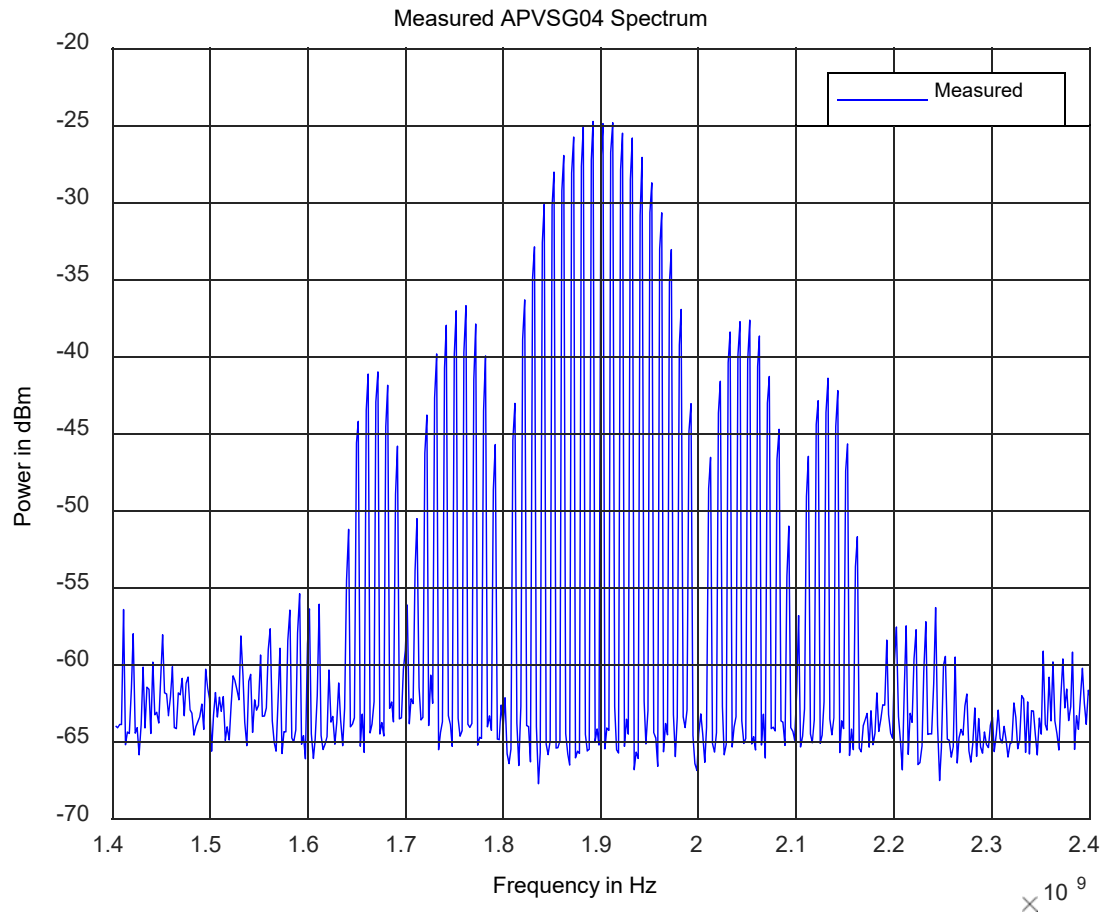
**Figure 9: Amplitude modulation (1 kHz rate, 80% depth)**



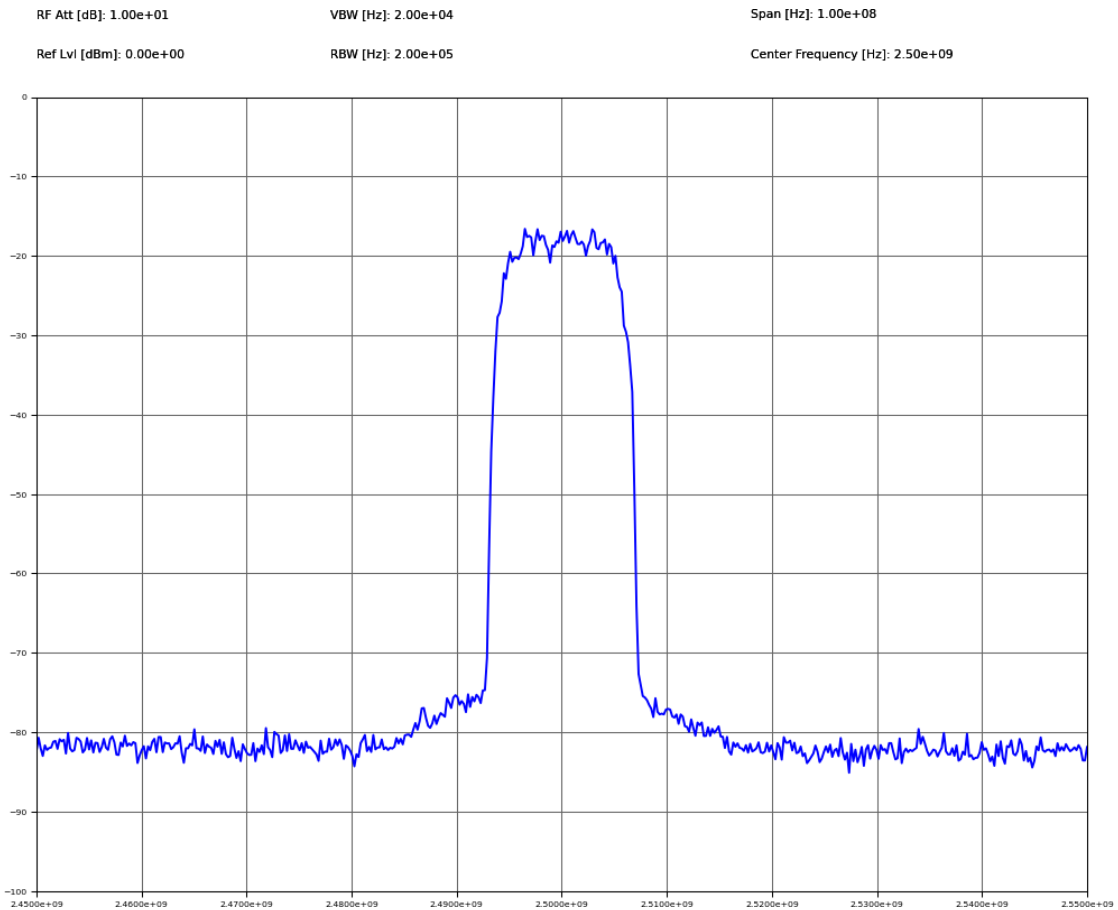
**Figure 10: DME Spectrum (X channel, raised cosine filter)**



**Figure 11: Pulse modulation (10 MHz rate, 10 ns pulse width)**

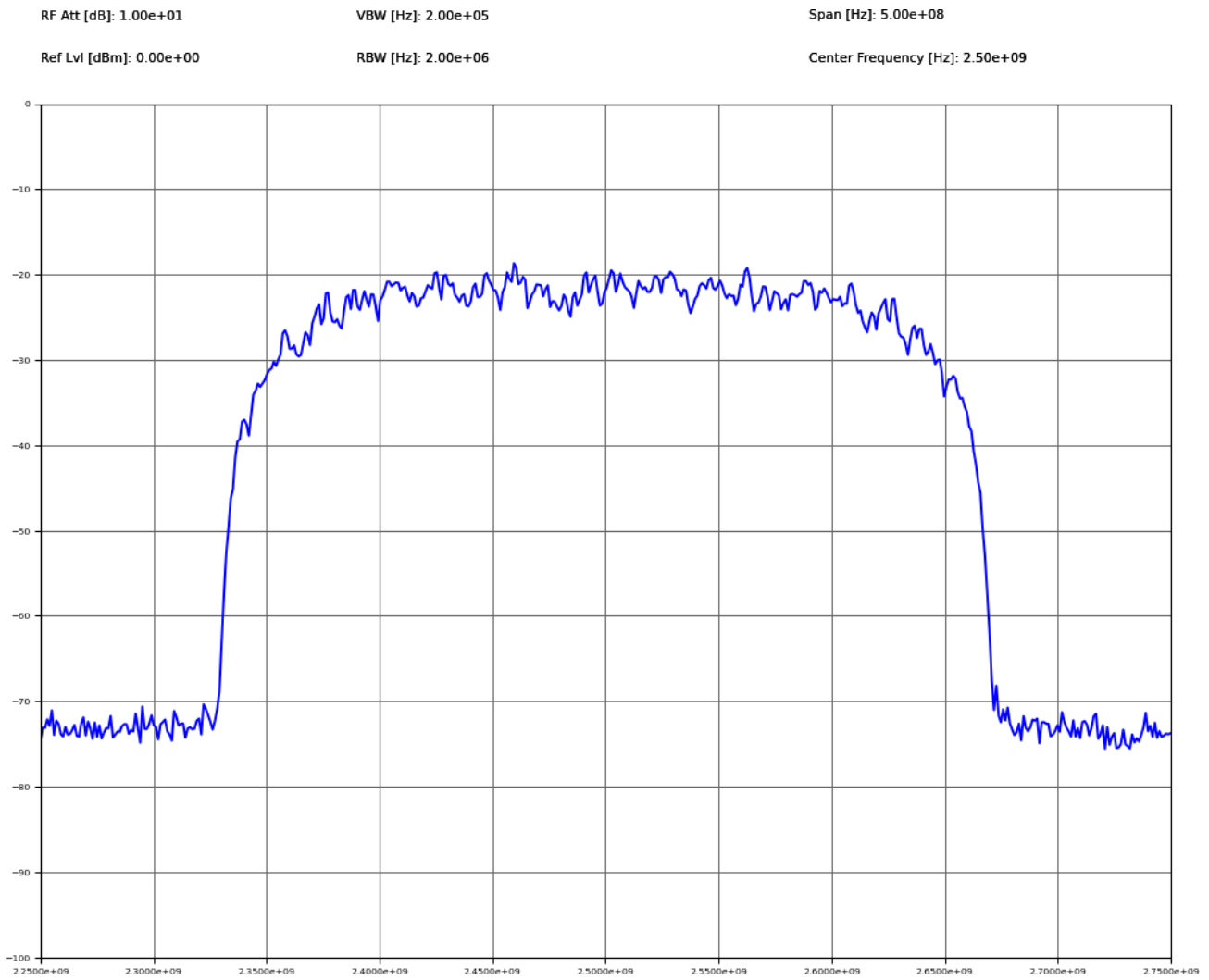


**Figure 12: 256QAM 10 MS/s**





**Figure 13: 16QAM 250 MS/s**



**Figure 14: EMV vs Output Power, 16QAM, 10 MS/s, 2.5 GHz**

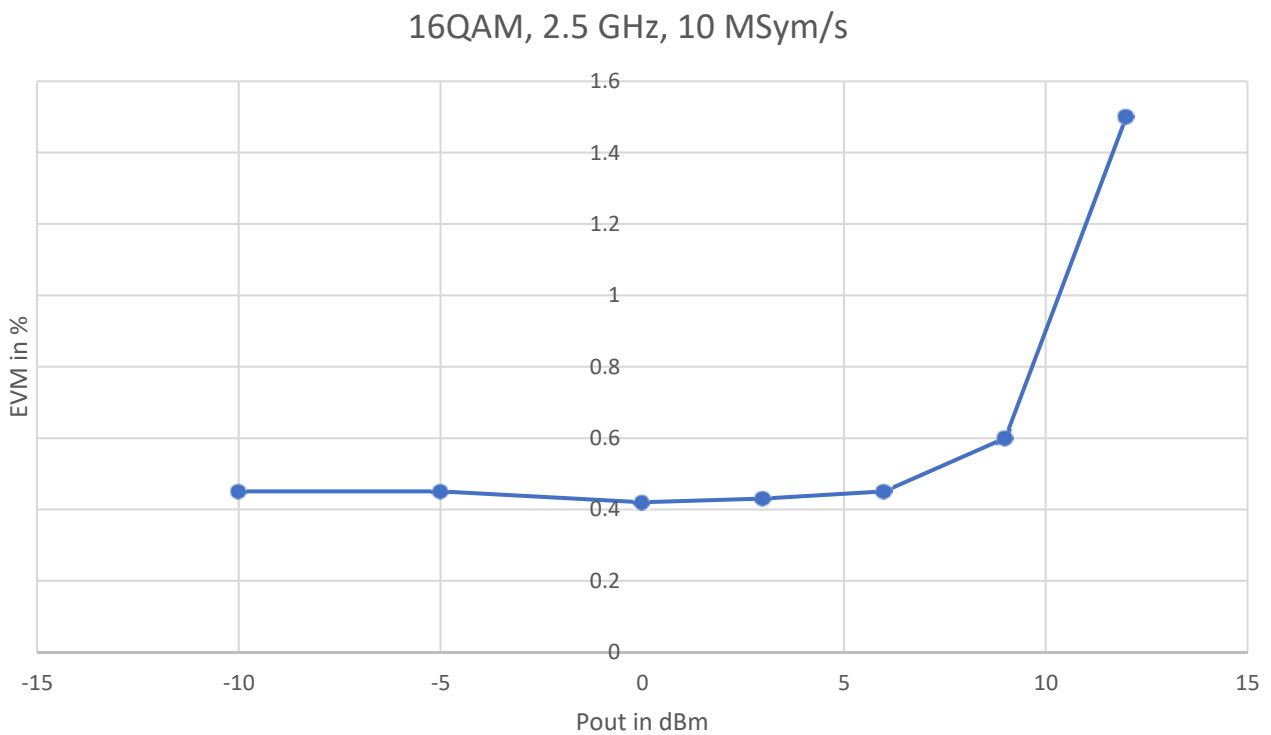


Figure 15: EMV vs Symbol Rate, 16QAM

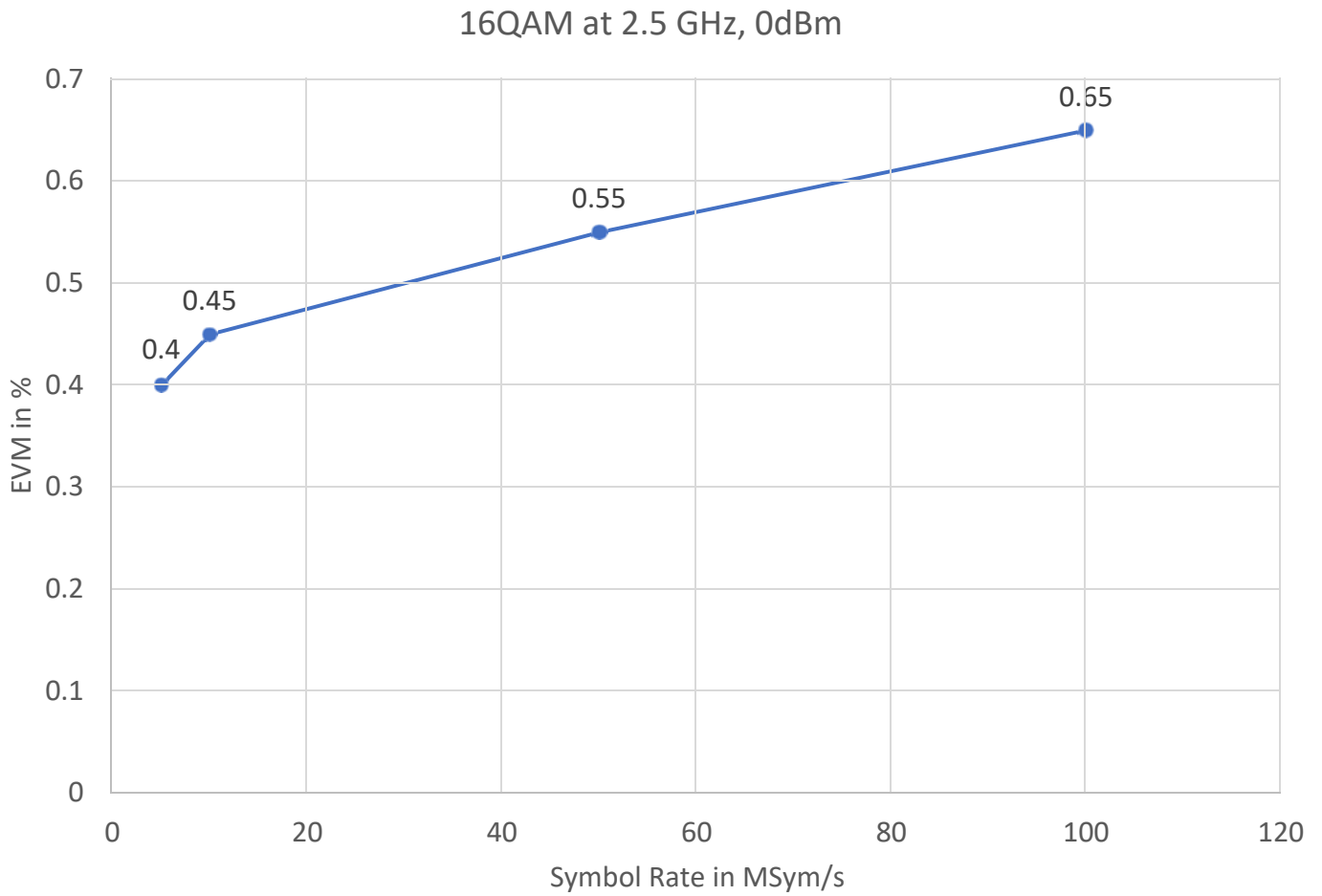
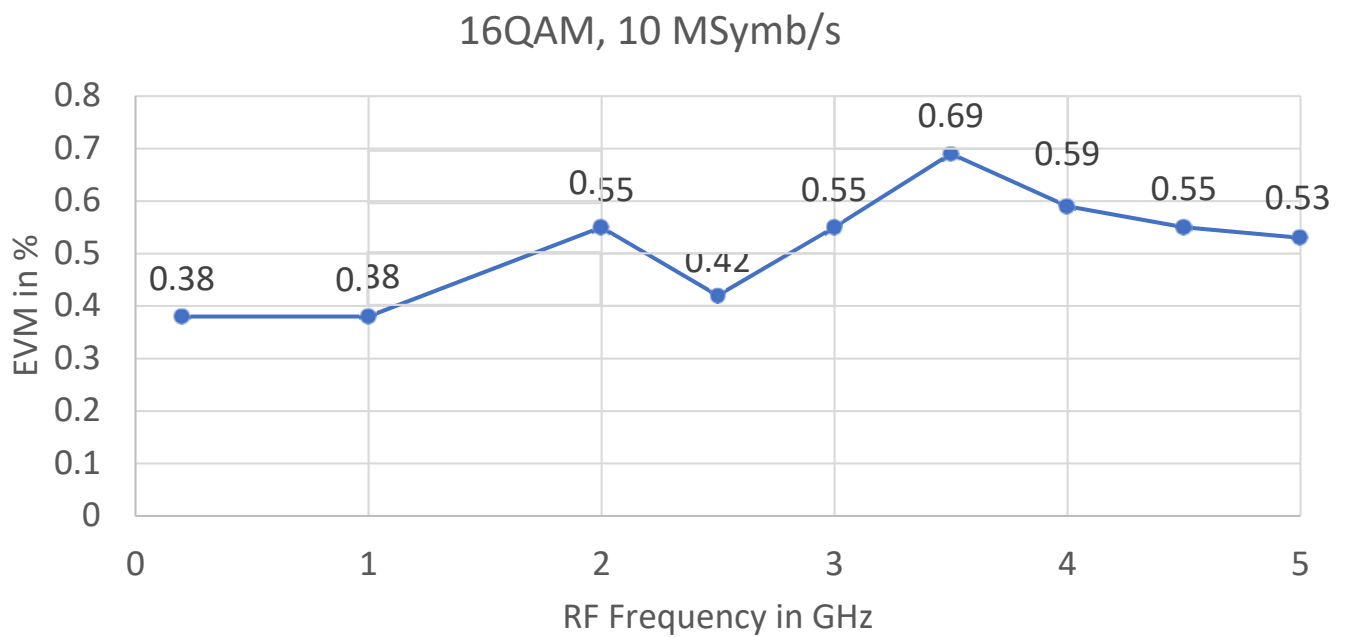
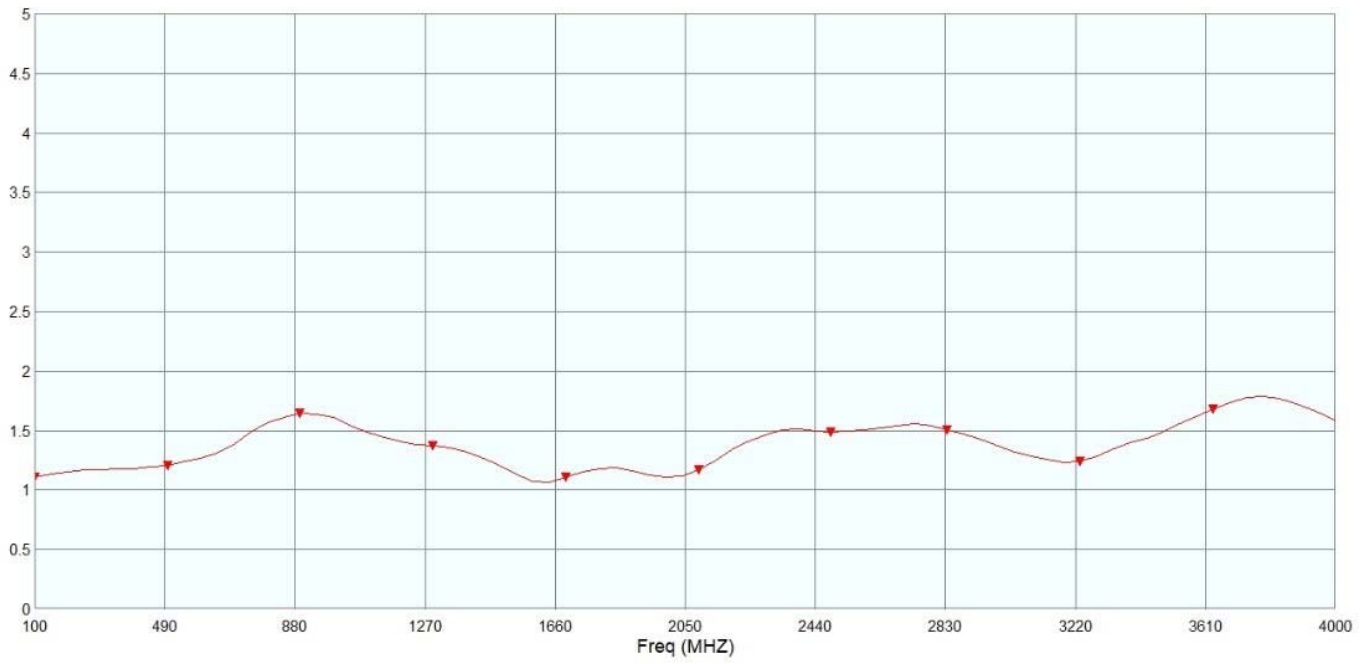


Figure 16: EMV vs RF Frequency, 16QAM, 10 Msymbols/s



**Figure 17: Typical VSWR (RFVSG04)**



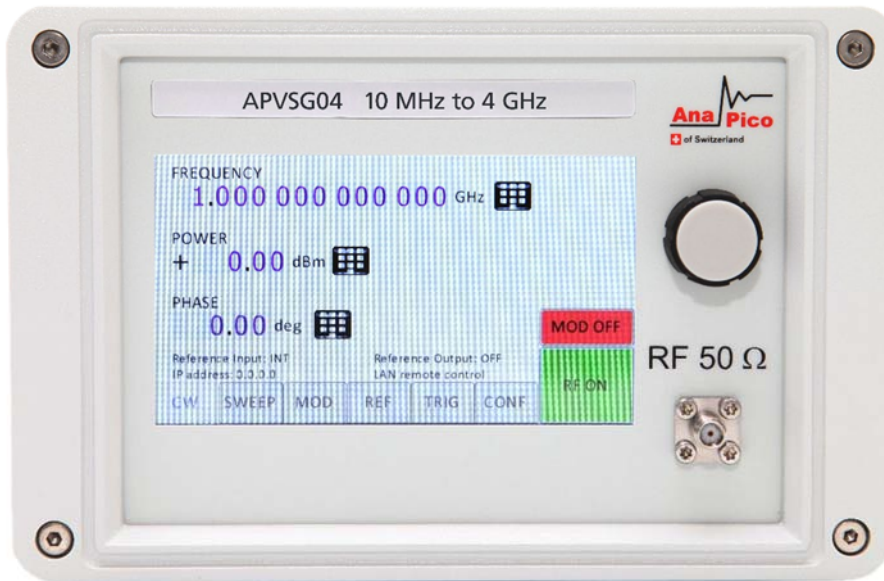
**Figure 18: Typical VSWR (RFVSG12)**

tbu

# CONNECTORS, IOS

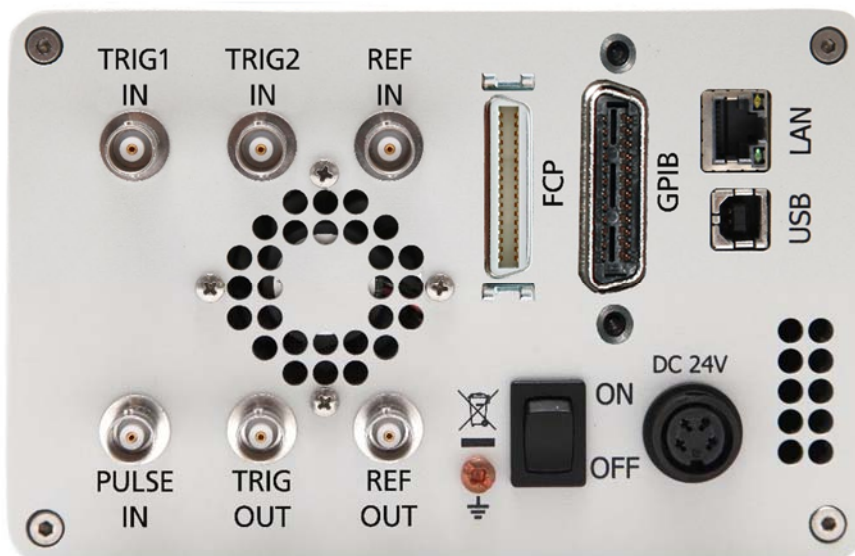
## Front panel (single channel model):

LABEL	TYPE	DESCRIPTION	OPTION
RF 50 Ω	N female (RFVSG04/RFVSG06/RFVSG12) SMA female (RFVSG20) K (2.92mm) female (RFVSG40)	RF output	



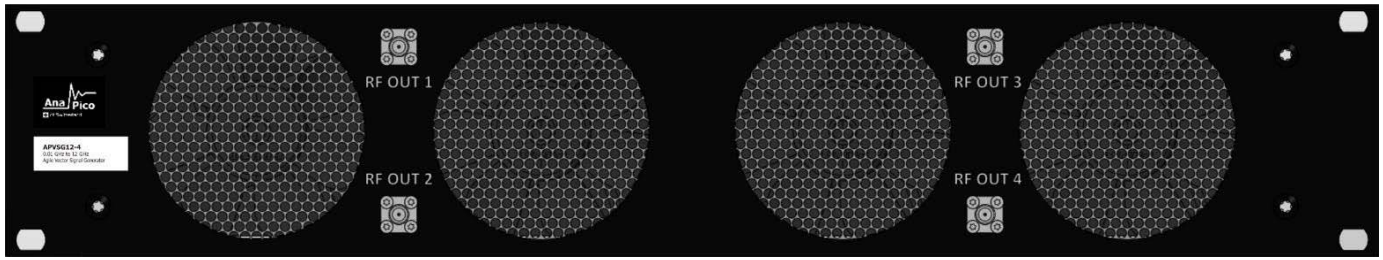
## Rear panel (single channel model):

LABEL	TYPE	DESCRIPTION	OPTION
USB	USB type B	Remote programming interface	
LAN	RJ-45	Remote programming interface	
GPIB	24-pin female	Remote programming interface	GPIB
DC24V	DC power plug female	Power of Instrument	
REF IN	BNC female	Reference frequency input	
REF OUT	BNC female	Reference frequency output	
FCP	36-pin mini-D female	Fast control port	FCP
MF1 IN, MF2 IN	BNC female	Multi-function inputs: user-configurable (e.g. trigger, external pulse)	
MF1 OUT, MF2 OUT	BNC female	Multi-function outputs: user-configurable (e.g. trigger, marker)	
I IN, Q IN	BNC female	Analog IQ-modulation inputs	AIQ



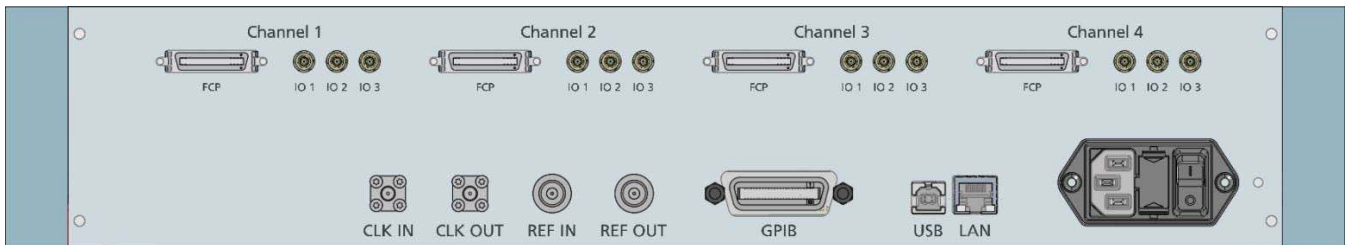
**Front panel (2U multi (2 to 8) channel model):**

LABEL	TYPE	DESCRIPTION	OPTION
RF OUT (for each channel)	SMA female / K (2.92mm) female (RFVSG40-X)	RF output	



**Rear panel (2U multi (2 to 8) channel model):**

LABEL	TYPE	DESCRIPTION	OPTION
USB	USB type B	Remote programming interface	
LAN	RJ-45	Remote programming interface	
GPIO	24-pin female	Remote programming interface	GPIO
REF IN	SMB female	Reference frequency input	
REF OUT	SMB female	Reference frequency output	
CLK IN	SMB female	High-stability reference input	
CLK OUT	SMB female	High-stability reference output	
FCP (for each channel)	36-pin mini-D female	Fast control port	FCP
MF1 IN, MF2 IN (for each channel)	SMB female	Multi-function inputs: user-configurable (e.g. trigger, external pulse)	
MF1 OUT, MF2 OUT (for each channel)	SMB female	Multi-function outputs: user-configurable (e.g. trigger, marker)	
I IN, Q IN (for each channel)	SMB female	Analog IQ-modulation inputs	AIQ



## ORDERING INFORMATION



HOST MODEL	PRODUCT	DESCRIPTION
RFVSG	RFVSG04	4 GHz model
RFVSG	RFVSG06	6 GHz model
RFVSG	RFVSG12	12 GHz model
RFVSG	RFVSG20	20 GHz model
RFVSG	RFVSG40	40 GHz model
RFVSG	RFVSG4	4 GHz model (X channels)
RFVSG	RFVSG6	6 GHz model (X channels)
RFVSG	RFVSG12	12 GHz model (X channels)
RFVSG	RFVSG20	20 GHz model (X channels)
RFVSG	RFVSG40	40 GHz model (X channels)
RFVSG		
RFVSG	<b>Option LN</b>	Enhanced close-in phase noise & frequency stability
RFVSG	<b>Option UFS</b>	Ultra-fast switching speed
RFVSG	<b>Option FCP</b>	Fast control port (digital IQ data streaming)
RFVSG	<b>Option MOD</b>	Analog modulations
RFVSG	<b>Option IVM</b>	Internal vector modulations
RFVSG	<b>Option AVIO</b>	Avionic modulations
RFVSG	<b>Option VREF</b>	Variable REF input
RFVSG	<b>Option AIQ</b>	External analog I/Q Inputs
RFVSG	<b>Option WE</b>	One year warranty extension
RFVSG	<b>Option ReCal</b>	Recalibration

# GENERAL CHARACTERISTICS

## Remote programming interfaces

- Ethernet 100BaseT LAN interface,
- USB 2.0 device interface
- GPIB (IEEE-488.2,1987) with listen and talk (optional)
- Control language SCPI Version 1999.0

## Power requirement:

**Single channel:** 24V ± 3.0 VDC; up to 65 W max

Mains adapter supplied: 100 - 240 VAC; 24 VDC and 2.71 A max

**Multi-channel:** 100 - 240 VAC, TBD W max

**Environmental** (Levels similar to MIL-PRF-28800F Class 3/4)

Environmental stress Samples of this product have been type tested to be robust against the environmental stresses of storage, transportation, and end-use; those stresses to temperature, humidity, shock, vibration, altitude, and power line conditions.

**Operating temperature range:** 0 to 45 °C

**Storage temperature range:** -40 to 70 °C

**Operating and storage altitude** up to 15,000 feet (4600 m)



notice

EMC complies to EMC regulations and directives for emission and immunity to interference (EN 61326-1 Industrial, EN/IEC 61326-2-1).

**Safety** complies to applicable safety regulation IEC/EN 61010-1.

This product complies with directive 2011/65/EU.

## Single-channel (portable / benchtop)

**Weight:** 2.5 kg (6 lbs) net, ≤ 4 kg (8 lb.) shipping

**Dimension:** 106 mm H x 172 mm W x 290 mm L (incl. connectors) [4.21 in H x 6.77 in W x 11.42 in L]

## Multi-channel (rack-mountable) 19" 2HU enclosure

**Weight:** 18 kg (37 lbs) net, ≤ 25 kg (8 lb.) shipping

**Dimension:** 86 mm H x 426 mm W x 480 mm L [3.4 in H x 16.8 in W x 18.9 in L]

**Recommended calibration cycle:** 24 months



## Document History

Version/Status	Date	Author	Notes
V110	2019-10-28	jk	Update
V111	2020-02-20	yg/jk	Update
V113	2020-03-31	jk	Analog modulations revised, option EIQ added, measurement plots added
V114	2020-04-31	jk	New plots added
V120	2020-11-10	jk	Extended to multi-channel, 12GHz model
V121	2021-1-10	jk	Power specs refined, data plots added

## AnaPico Ltd.

Europastrasse 9  
8152 Glattbrugg  
Switzerland

Phone +41 44 440 00 50  
Email sales@anapico.com

www.anapico.com  
www.anapico.com/downloads/

