

**Anritsu** Advancing beyond

# Rubidium™

Low Noise RF/Microwave Signal Generator

## MG36221A

9 kHz to 20 GHz

## MG36241A

9 kHz to 43.5 GHz



## OVERVIEW

Signal purity and frequency stability are core performance metrics that mark excellence of any RF/Microwave signal generator. Anritsu's new Rubidium MG362x1A signal generator product line pushes the performance envelope of signal purity and frequency stability to new levels that are unmatched in the industry. Its built-in, easy-to-use, at location frequency and power calibration capability offers exceptional overall utility and value to customers. With Anritsu's proven record of high-reliability and long-term support, Rubidium MG362x1A signal generators are the best choice for a wide range of measurement applications.

### Key Features

- Exceptionally low single sideband SSB phase noise of -136 dBc/Hz (typical) and -140 dBc/Hz (measured) at 10 GHz and 10 kHz offset
- Very low harmonic of < -58 dBc and spurious < -63 dBc
- Atomic clock frequency stability of < 8E-12 Allan deviation (over 100 sec), aging rate < 1E-9 per year, with T&M grade phase noise
- Optional on-site frequency and level calibration capability integrated (requires Anritsu MA243xxA USB power sensor and Option 66)
- Wide range of interfaces for remote control such as 6 x USB 3.0, 1 x 10/100/1000 Ethernet, 1 x GPIB
- Industry standard IVI.NET and IVI-C drivers and SCPI support for remote instrument control
- Easy to navigate GUI that supports a new 7-inch touch screen and traditional front panel keypad/dial

### Outstanding Signal Purity

SSB Phase Noise is the most important measure of signal purity in a signal generator. Phase noise of the standard Rubidium signal generator outperforms phase noise offered by most signal generators in the market today with a robust margin. Additionally, Rubidium offers two low phase noise options which provide performance that is unmatched in the market:

1. Low Phase Noise (Option 3): This option enhances close in phase noise (< 1 kHz) performance and frequency stability of the Rubidium standard unit. Low close in phase noise is critical in many measurement applications such as testing doppler radars that detect very slow moving targets.
2. Ultra Low Phase Noise (Option 13): This option offers the best phase noise across the entire range of offsets from 10 Hz to 100 MHz. Phase noise across the entire range of offsets yields superior integrated phase noise which is important when the signal generator is used as a local oscillator (LO) source for testing up/down converters or when used as a clock source to test ADCs/DACs.

In addition to the two low phase noise options, for CW only applications between 2 GHz to 20 GHz, Rubidium's Option 23 provides an even lower phase noise. The ultra low phase noise option achieves a ground breaking -140 dBc/Hz at 10 GHz and 10 kHz offset.

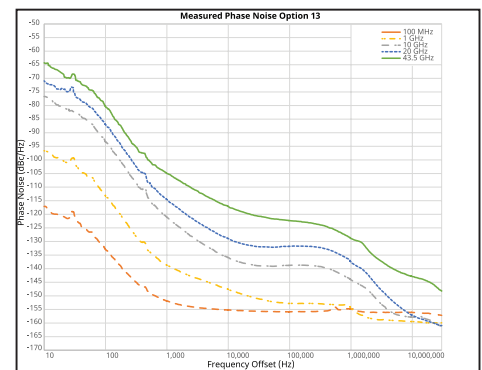
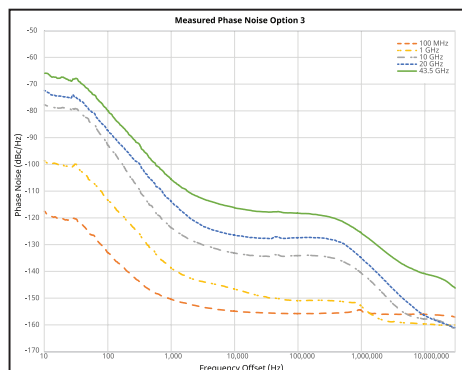
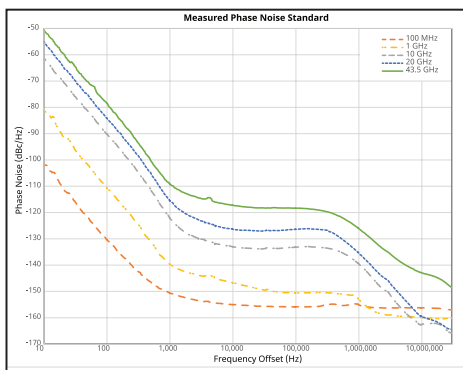

## Atomic Clock Timebase and Frequency Stability

Frequency stability and accuracy of a signal generator are critical in many measurement applications. The Rubidium MG362x1A signal generator offers two options that provide order-of-magnitude and better frequency stability and accuracy than a typical oven controlled crystal (OCXO) reference.

1. Ultra Stability Timebase (Option 56): This option adds an internal Rubidium clock timebase that provides exceptional medium and long term frequency stability while still maintaining T&M grade phase noise. With an order-of-magnitude lower aging rate than a typical OCXO, rubidium clock reference can provide much better frequency accuracy.
2. GNSS/GPS Atomic Clock Receiver (Option 66): This option adds an internal GNSS/GPS atomic clock receiver. The receiver generates an accurate one pulse per sec (1 PPS) signal when connected to a GNSS/GPS satellite signal which is used to control the signal generator's internal OCXO or a rubidium clock time base. Continuous closed loop locking of internal time base to the 1 PPS reference signal practically eliminates aging. The accuracy and stability achieved are the same as an atomic clock time.

Parameter	Rubidium with Option 56	Sig Gen with OCXO Ref
Aging rate per day	$< \pm 2 \times 10^{-11}$	$< \pm 5 \times 10^{-10}$
Aging rate per year	$< \pm 1 \times 10^{-9}$	$< \pm 3 \times 10^{-8}$
Temperature effects from 0 to +55 °C	$< \pm 3 \times 10^{-10}$	$< \pm 3 \times 10^{-9}$
Short-term stability (Allan deviation) per 100 s	$< \pm 8 \times 10^{-12}$	NA

Options 56 and 66 are ideal for signal generator applications in metrology and calibration labs, astronomy research, and satellite ground stations as shown in figure 1. Option 56 (Rubidium clock) is well suited for defense applications that require a very stable and independent reference not tied to a GPS/GNSS signal (see figure 2).

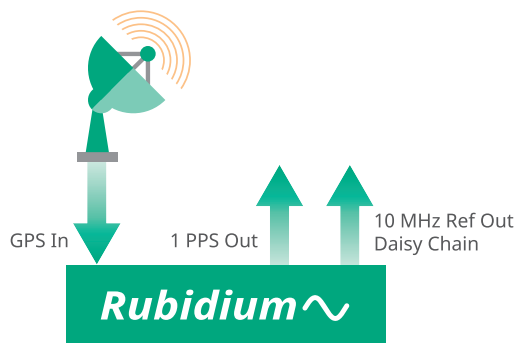

Figure 1. GNSS/GPS Disciplined Reference

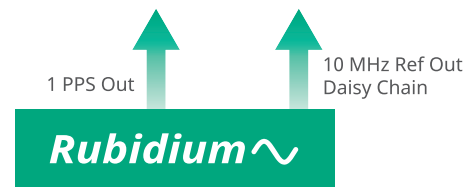

Figure 2. Rubidium Atomic Clock Reference

### On-Site Frequency and Level Calibration

The Rubidium MG362x1A signal generator features on-site frequency and level calibration capability built in to the instrument. The on-site frequency and power calibration is accomplished at the touch of a button on the GUI interface. When customers want to ensure frequency and level accuracy of the instrument, it can be done without ever sending the instrument to a calibration lab. This saves time and cost for the customer and increases instrument availability.

On-site frequency calibration is accomplished by connecting Rubidium MG362x1A signal generator's GNSS/GPS receiver to an outdoor antenna and locking to the satellite signal. The GNSS/GPS receiver provides a very stable and accurate 1PPS clock for recalibrating the internal time base. An Anritsu power sensor is needed for on-site level calibration of Rubidium signal generator.



*Rubidium MG362x1A Signal Generator Connected to an MA243xxA Power Sensor and GPS Antenna*

## Elegant and Easy to Navigate Touch Screen Interface

The Rubidium MG362x1A signal generator front panel has a 7-inch touch screen along with traditional keypad and rotary dial interface that satisfies needs of a wide diversity of customers.

The graphical user interface is designed such that essential information about the state of the instrument and most important settings are always visible to the user at the top. The navigation through various menus is intuitive and streamlined such that the user can set the parameters with minimum number of touches or key presses.

The GUI has several features that enable the user to quickly and efficiently set up the signal generator for measurement. The user can set up a range of frequency, level, and sweep presets and recall them with a single touch. On many parameter setting screens, the user can reset parameters with a single touch.

The touch screen interface can be controlled using a keyboard attached to the USB 3.0 ports on the front panel. In addition, the signal generator can be controlled over Ethernet with a remote GUI interface hosted on a Windows laptop or a PC.

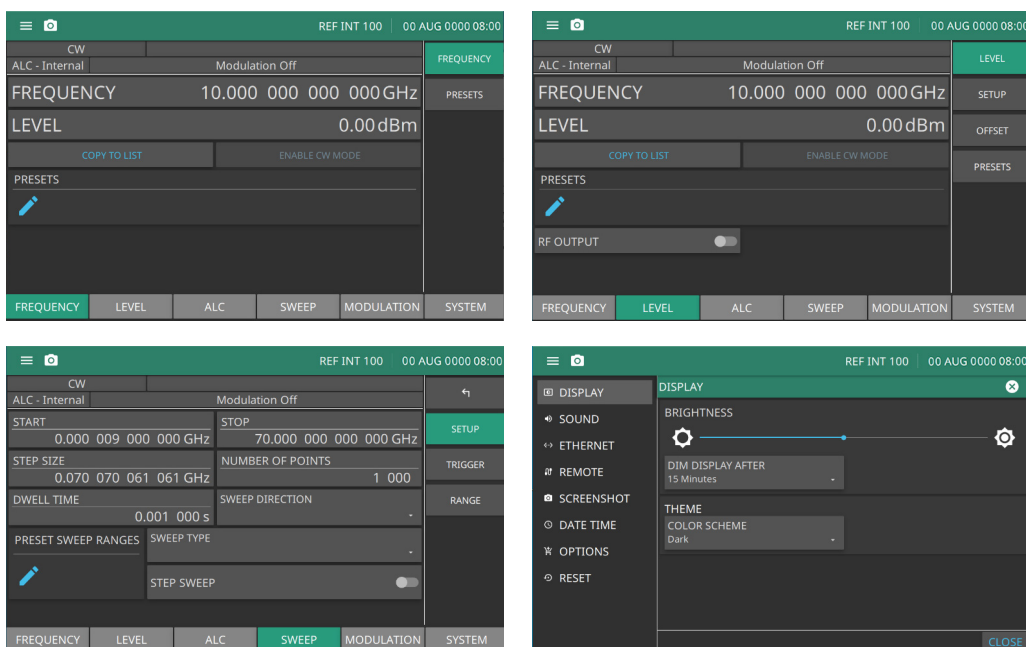

### Complex Analog Modulation Signals

The Rubidium MG362x1A signal generator features extensive internal waveform generation capabilities. Seven different waveform types can be generated internally and can be used to modulate the carrier in AM/FM/PM modes:

- Sine waves
- Square waves
- Positive/negative going ramps
- Triangles
- Gaussian noise
- Uniform noise

Simultaneous modulation of AM/FM, AM/PM, and FM/Pulse modulation are possible. This enables generation of complex modulation waveforms such as chirps.

The Rubidium signal generator provides modulation input connectors on the front panel as an option. This feature minimizes distortion of external modulation inputs such as narrow pulses due to use of long cables.

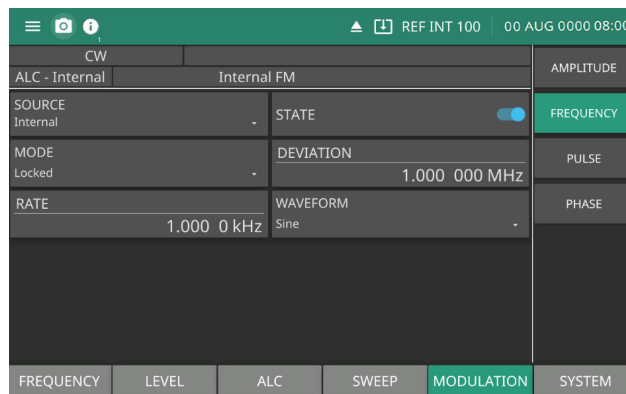

### Rubidium MG362x1A Signal Generator Key Specifications

Parameter	Specification
Frequency Range	9 kHz to 20/43.5 GHz
Frequency Resolution	0.001 Hz
SSB Phase Noise	-136 dBc/Hz (typical) and -140 dBc/Hz (measured) @ 10 GHz output, 10 kHz offset
Internal Time Base Stability - Aging	< $\pm 5 \times 10^{-7}$ Standard < $\pm 2 \times 10^{-8}$ per year with Option 3 < $\pm 1 \times 10^{-9}$ per year with Option 56
Reference Output Frequency	10 MHz, 100 MHz, and 1.6 GHz
Output Power	-130 dBm to +20 dBm (20 GHz, standard option) -130 dBm to +18 dBm (43.5 GHz, standard option)
Level Accuracy and Flatness	$\pm 1$ dB (43.5 GHz)
Harmonics (9 KHz to 20/43.5 GHz)	-58 dBc
Non Harmonics (9 KHz to 20/43.5 GHz)	-63 dBc
Modulation	AM, FM, PM, and Pulse
Pulse Modulation: Min Pulse Width	< 10 ns (Unleveled)
Pulse Modulation: Rise/Fall Times	5 ns (typical)
LF Signal Generator Waveforms	Sine, square, pulse, triangle, ramp, GN/UN noise
Frequency Sweep Modes	Step, List
Frequency Sweep Width	9 kHz to full frequency range (step, list)
Power Sweep	Step, List
Power Sweep Resolution	0.01 dB/step

### Application Use Cases for Rubidium MG362x1A Signal Generator

- Making nonlinear measurements
  - Single tone distortion – P1 dB compression point
  - Two tone intermodulation – IP2, IP3
  - In-band and out-of-band interference (C/I, blocking)
- As signal source to test devices and systems
  - Pulse modulated signal source to test radar systems
  - As pure CW source for LO substitution in testing of transceiver chains
  - Clock and CW source for testing Gbit data converters analog-to-digital converter and digital-to-analog converter (ADC and DAC)
- Making swept linear measurements
  - As additional sources synchronized with vector network analyzer
- As frequency reference in calibration and metrology labs



## Interfaces

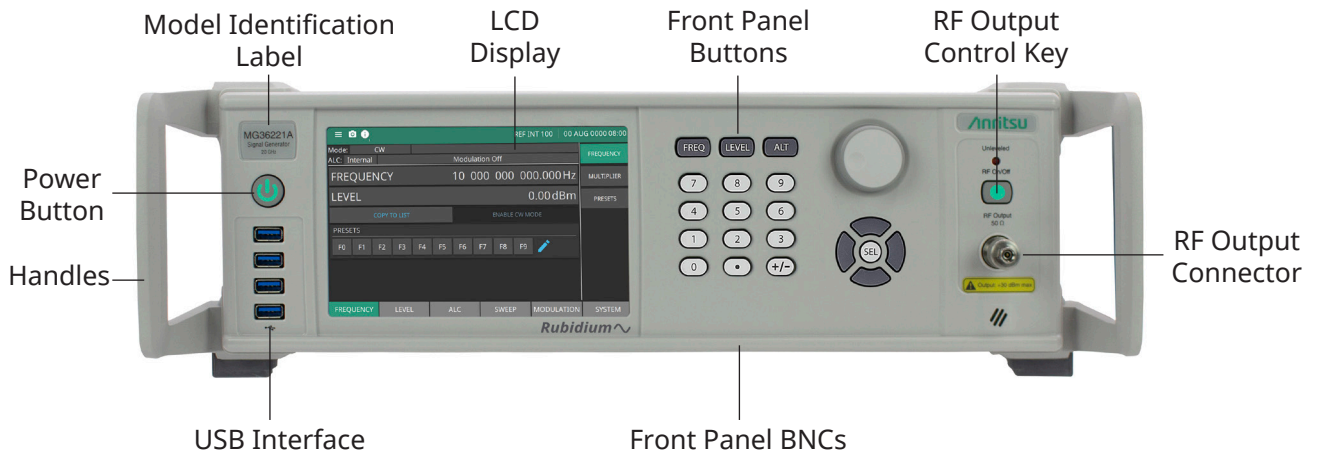

*Rubidium MG362x1A Signal Generator Front Panel*

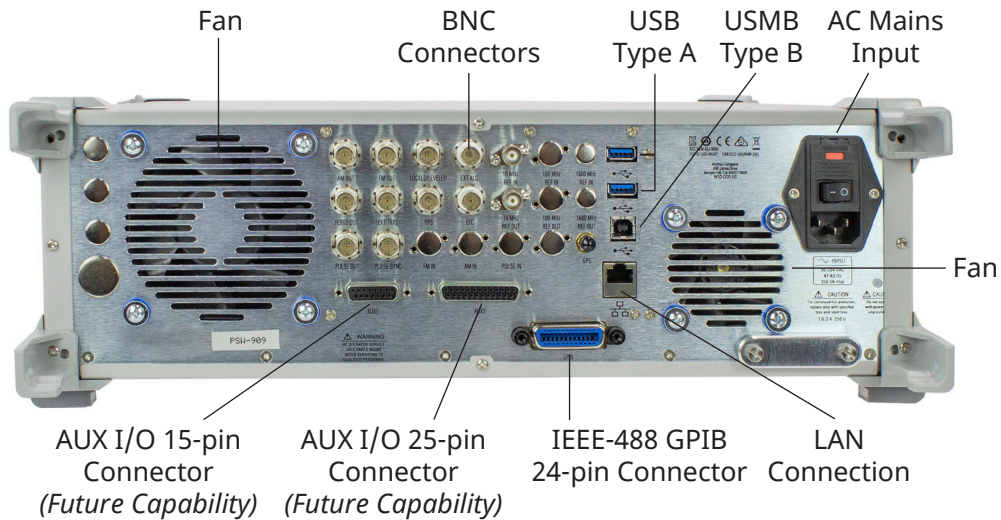

*Rubidium MG362x1A Signal Generator Back Panel*



### Inputs and Outputs

Description	<b>Connectors may be available but not active if the option is not ordered.</b>
EXT ALC	Provides for leveling the RF output signal externally with either a detector or power meter. Signal requirements are shown in the RF output specifications. BNC type, rear panel
RF OUTPUT	Provides for RF output from 50 $\Omega$ source impedance. Option 9 moves the RF Output connector from the front to the rear panel. K Connector (male) $f_{max} \leq 43.5$ GHz
10 MHz REF IN	Accepts an external 10 MHz $\pm 3$ Hz, 0 dBm to +10 dBm (20 dBm no-damage level) time-base signal. Automatically disconnects the internal high-stability time-base option, if connected. 50 $\Omega$ impedance BNC type, rear panel
10 MHz REF OUT	Provides a 10 dBm, AC coupled, signal derived from the internal frequency standard. 50 $\Omega$ impedance BNC type, rear panel
100 MHz REF IN	Accepts an external 100 MHz $\pm 200$ Hz or 2 PPM, 12 $\pm 1$ dBm (20 dBm no-damage level) reference signal. Enabled with option 3 or 13. Automatically disconnects the internal high-stability time-base option, if connected. 50 $\Omega$ impedance BNC type, rear panel
100 MHz REF OUT	Provides a 12 dBm, AC coupled, 100 MHz signal derived from the internal frequency standard. Enabled with Option 3 or 13. 50 $\Omega$ impedance BNC type, rear panel
1600 MHz REF IN	Accepts an external 1600 MHz $\pm 3.2$ kHz or 2 PPM, 4 $\pm 1$ dBm (20 dBm no-damage level) reference signal. Enabled with option 3 or 13. Automatically disconnects the internal high-stability time-base option, if connected. 50 $\Omega$ impedance SMA type, rear panel
1600 MHz REF OUT	Provides a 5 dBm, AC coupled, 1600 MHz signal derived from the internal frequency standard. Enabled with Option 3 or 13. 50 $\Omega$ impedance SMA type, rear panel

### Inputs and Outputs

EFC	<p>±4 VDC 30 Hz bandwidth in wide reference PLL mode 1 M<math>\Omega</math> input impedance. Provides the capability to frequency modulate the internal crystal oscillator, allowing phase locking of the synthesizer inside an external lock loop. BNC type, rear panel</p>
ETHERNET (1000 Base-T)	<p>Provides input/output connections for a Gigabit Ethernet interface. RJ45 type, rear panel</p>
GPIB (IEEE-488)	<p>Provides input/output connections for the General Purpose Interface Bus (GPIB).</p>
PULSE IN	<p>Accepts an external TTL compatible signal to pulse modulate the RF output signal or to trigger or to gate the optional internal pulse generator. Enabled with Option 26. BNC type, rear panel</p>
PULSE SYNC	<p>Provides a TTL compatible signal, synchronized to the internal pulse modulation output. Enabled with Option 26. BNC type, rear panel</p>
PULSE OUT	<p>Provides a video modulating signal from the internal pulse generator. Enabled with Option 27. BNC type, rear panel</p>
AM IN	<p>Accepts an external signal to amplitude modulate the RF output signal. Enabled with Option 12. 50 <math>\Omega</math> impedance BNC type, rear panel.</p>
FM IN	<p>Accepts an external signal to frequency or phase modulate the RF output signal. Enabled with Option 12. 50 <math>\Omega</math> impedance BNC type, rear panel.</p>

### Inputs and Outputs

AM OUT	Provides the amplitude modulation waveform from the internal LF generator. Enabled with Option 27. 50 $\Omega$ impedance. BNC type, rear panel.
FM OUT	Provides the frequency or phase modulation waveform from the internal LF generator. Enabled with Option 27. BNC type, rear panel.
LOCKED/LEVELED	TTL high/low output signal when in internal ALC mode that is a logical AND of frequency locked condition and output leveled condition. When in Fixed Gain mode this signal indicates only frequency locked/unlocked condition.
PPS	1PPS input/output from either GNSS/GPS atomic clock receiver or internal Rubidium reference option. 3.3V CMOS I/O.
GPS	Accepts GNSS/GPS antenna input
USB	Two USB 3.0 type A for peripherals such as memory device One USB 2.0 type B for USB-TMC.
SD CARD	Accepts an external SDIO memory card.
AC POWER INPUT	AC Input connector, with On/Off switch, and fuses 350 VA maximum, 90 to 264 VAC, 47 to 63 Hz

## Ordering Information

<b>Part Number</b>	<b>Description</b>
MG36221A	Signal Generator 9 kHz to 20 GHz
<b>Options</b>	
MG36221A-0001	Rack Mount with Slides (Cannot be ordered with Option 11)
MG36221A-0002	Mechanical Step Attenuator, 110 dB
MG36221A-0003	Low Phase Noise and High Stability (Required for Option 13)
MG36221A-0009	Rear Panel K-Connector RF Output
MG36221A-0011	Rack Mount without Slides, Shelf Mount
MG36221A-0012	Amplitude, Frequency, and Phase Modulation, Internal/External (Requires Option 27 )
MG36221A-0013	Ultra Low Phase Noise (Requires Option 3)
MG36221A-0015	High Power Output
MG36221A-0018	On-Site Level and Frequency Calibration (Requires Option 66 and MA24330A/MA24350A USB Power Sensor, Sold Separately)
MG36221A-0023	Premium Noise, CW (Requires Option 3 and 13)
MG36221A-0026	Pulse Modulation, Internal/External (Requires Option 27)
MG36221A-0027	Modulation Hardware (Requires Option 12, 26, or Both for Functionality)
MG36221A-0029	Front Panel Modulation Input/Output Access (Requires Option 27)
MG36221A-0056	Ultra Stability Time Base (Requires Option 3 or 13)
MG36221A-0066	GNSS Atomic Clock Receiver (Requires Option 3 or 13)
MG36221A-0097	Accredited Calibration
MG36221A-0098	Standard Calibration
MG36221A-0099	Premium Calibration
MG36241A	Signal Generator, 9 kHz to 43.5 GHz
MG36241A-0001	Rack Mount with Slides (Cannot be Ordered with Option 11)
MG36241A-0002	Mechanical Step Attenuator, 90 dB
MG36241A-0003	Low Phase Noise and High Stability (Requires Option 13)
MG36241A-0009	Rear Panel K-Connector RF Output
MG36241A-0011	Rack Mount without Slides (Shelf Mount)
MG36241A-0012	Amplitude, Frequency, and Phase Modulation, Internal/External (Requires Option 27 )
MG36241A-0013	Ultra Low Phase Noise (Requires Option 3)
MG36241A-0015	High Power Output
MG36241A-0018	On-Site Level and Frequency Calibration (Requires Option 66 and MA24350A USB Power Sensor, Sold Separately)
MG36241A-0026	Pulse Modulation, Internal/External (Requires Option 27)
MG36241A-0027	Modulation Hardware (Requires Option 12, 26, or Both for Functionality)
MG36241A-0029	Front Panel Modulation Input/Output Access (Requires Option 27)
MG36221A-0056	Ultra Stability Time Base (Requires Option 3 or 13)
MG36221A-0066	GNSS Atomic Clock Receiver (Requires Option 3 or 13)
MG36241A-0097	Option 97, Accredited Calibration
MG36241A-0098	Option 98, Standard Calibration
MG36241A-0099	Option 99, Premium Calibration

• **United States**

**Anritsu Americas Sales Company**

450 Century Parkway, Suite 190, Allen, TX 75013 U.S.A.  
Phone: +1-800-Anritsu (1-800-267-4878)

• **Canada**

**Anritsu Electronics Ltd.**

700 Silver Seven Road, Suite 120, Kanata,  
Ontario K2V 1C3, Canada  
Phone: +1-613-591-2003  
Fax: +1-613-591-1006

• **Brazil**

**Anritsu Eletronica Ltda.**

Praça Amadeu Amaral, 27 - 1 Andar  
01327-010 - Bela Vista - Sao Paulo - SP, Brazil  
Phone: +55-11-3283-2511  
Fax: +55-11-3288-6940

• **Mexico**

**Anritsu Company, S.A. de C.V.**

Bldv Miguel de Cervantes Saavedra #169 Piso 1, Col. Granada  
Mexico, Ciudad de Mexico, 11520, MEXICO  
Phone: +52-55-4169-7104

• **United Kingdom**

**Anritsu EMEA Ltd.**

200 Capability Green, Luton, Bedfordshire, LU1 3LU, U.K.  
Phone: +44-1582-433200  
Fax: +44-1582-731303

• **France**

**Anritsu S.A.**

12 avenue du Québec, Immeuble Goyave,  
91140 VILLEBON SUR YVETTE, France  
Phone: +33-1-60-92-15-50

• **Germany**

**Anritsu GmbH**

Nemetschek Haus, Konrad-Zuse-Platz 1,  
81829 München, Germany  
Phone: +49-89-442308-0  
Fax: +49-89-442308-55

• **Italy**

**Anritsu S.r.l.**

Spaces Eur Arte, Viale dell'Arte 25, 00144 Roma, Italy  
Phone: +39-6-509-9711

• **Sweden**

**Anritsu AB**

Kistagången 20 B, 2 tr, 164 40 Kista, Sweden  
Phone: +46-8-534-707-00

• **Finland**

**Anritsu AB**

Technopolis Aviapolis, Teknobulevardi 3-5 (D208.5.),  
FI-01530 Vantaa, Finland  
Phone: +358-20-741-8100

• **Denmark**

**Anritsu A/S**

c/o Regus Winghouse, Ørestads Boulevard 73, 4th floor,  
2300 Copenhagen S, Denmark  
Phone: +45-7211-2200

• **Russia**

**Anritsu EMEA Ltd.**

**Representation Office in Russia**

Tverskaya str. 16/2, bld. 1, 7th floor., Moscow, 125009, Russia  
Phone: +7-495-363-1694  
Fax: +7-495-935-8962

• **Spain**

**Anritsu EMEA Ltd.**

**Representation Office in Spain**

Paseo de la Castellana, 141. Planta 5, Edificio Cuzco IV  
28046, Madrid, Spain  
Phone: +34-91-572-6761

• **Austria**

**Anritsu EMEA GmbH**

Am Belvedere 10, A-1100 Vienna, Austria  
Phone: +43-(0)1-717-28-710

• **United Arab Emirates**

**Anritsu EMEA Ltd.**

**Anritsu A/S**

Office No. 164, Building 17, Dubai Internet City  
P. O. Box – 501901, Dubai, United Arab Emirates  
Phone: +971-4-3758479

• **India**

**Anritsu India Private Limited**

6th Floor, Indiqube ETA, No.38/4, Adjacent to EMC2,  
Doddanekundi, Outer Ring Road, Bengaluru – 560048, India  
Phone: +91-80-6728-1300  
Fax: +91-80-6728-1301

• **Singapore**

**Anritsu Pte. Ltd.**

11 Chang Charn Road, #04-01, Shriro House, Singapore 159640  
Phone: +65-6282-2400  
Fax: +65-6282-2533

• **Vietnam**

**Anritsu Company Limited**

16th Floor, Peakview Tower, 36 Hoang Cau Street, O Cho Dua Ward,  
Dong Da District, Hanoi, Vietnam  
Phone: +84-24-3201-2730

• **P.R. China (Shanghai)**

**Anritsu (China) Co., Ltd.**

Room 2701-2705, Tower A, New Caohejing International  
Business Center No. 391 Gui Ping Road Shanghai, 200233, P.R. China  
Phone: +86-21-6237-0898  
Fax: +86-21-6237-0899

• **P.R. China (Hong Kong)**

**Anritsu Company Ltd.**

Unit 1006-7, 10/F., Greenfield Tower, Concordia Plaza,  
No. 1 Science Museum Road, Tsim Sha Tsui East,  
Kowloon, Hong Kong, P.R. China  
Phone: +852-2301-4980  
Fax: +852-2301-3545

• **Japan**

**Anritsu Corporation**

8-5, Tamura-cho, Atsugi-shi, Kanagawa, 243-0016 Japan  
Phone: +81-46-296-6509  
Fax: +81-46-225-8352

• **Korea**

**Anritsu Corporation, Ltd.**

5FL, 235 Pangyoeyeok-ro, Bundang-gu, Seongnam-si,  
Gyeonggi-do, 13494 Korea  
Phone: +82-31-696-7750  
Fax: +82-31-696-7751

• **Australia**

**Anritsu Pty. Ltd.**

Unit 20, 21-35 Ricketts Road, Mount Waverley, Victoria 3149, Australia  
Phone: +61-3-9558-8177  
Fax: +61-3-9558-8255

• **Taiwan**

**Anritsu Company Inc.**

7F, No. 316, Sec. 1, NeiHu Rd., Taipei 114, Taiwan  
Phone: +886-2-8751-1816  
Fax: +886-2-8751-1817

List Revision Date: 20210610



Anritsu utilizes recycled paper and environmentally conscious inks and toner.



© Anritsu All trademarks are registered trademarks of their respective owners. Data subject to change without notice. For the most recent specifications, visit: [www.anritsu.com](http://www.anritsu.com)